

5

CHARRUA

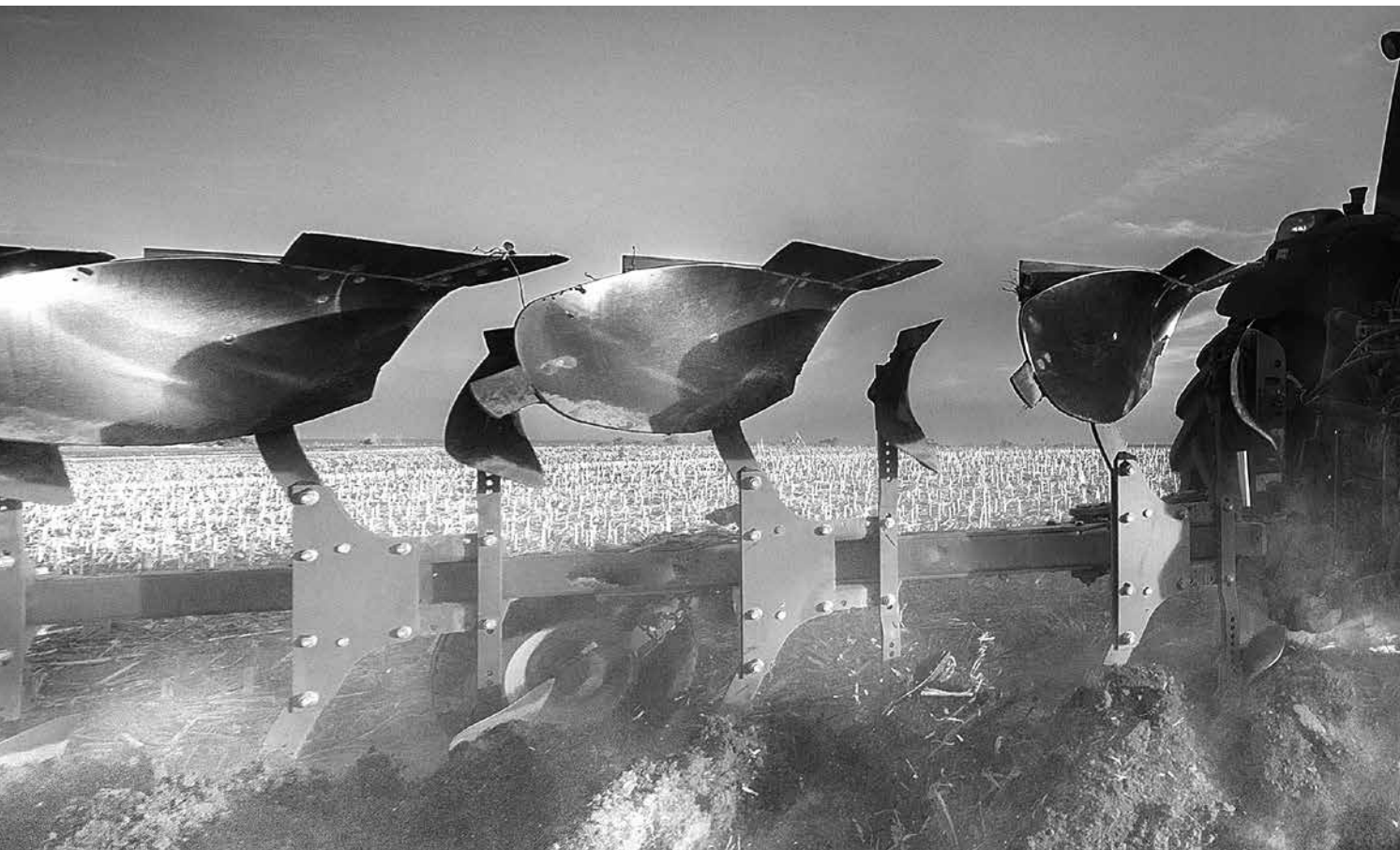

5.1

Eco-charrua Bellota

5.2

Conjunto
charrua chisel

5.3

Relhas universais
para charruas

5.4

Aivecas universais

5.5

Balestras
para charrua

5.6

Kverneland

5.7

Kuhn

5.8

Överum

5.9

Fiskars-Agrolux

5.10

Vogel & Noot

5.11

Naud

5.12

Dowdeswell

5.13

International
Harvester

5.14

Ovlac

5.15

Escudero

1

PLANTIO

2

DESCOMPACTADOR
DENTES CORVOS

3

CULTIVADOR

4

GRADE

5

CHARRUA

ECO-CHARRUA

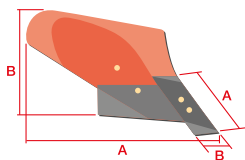

Para um correcto trabalho recomenda-se uma largura de trabalho de 280 mm. O ângulo de ataque recomendado entre o filo da relha (uma vez colocado não braço e amarre) e o solo é de aproximadamente 3°.



1345-2

Ref.	— —	A	B	Grs.				M	F
1345-40 2 D				17.800	1	30			
1345B-40 2 D				18.900	1	30			
1833-2 D CA	8	575	320	7.300	3	84	1199B	M12	
1833-2 I CA	8	575	320	7.300	3	84	1199B	M12	50
1342B-40 D				7.000		40	1345B-TAV		
1342B-40 I				7.000		40	1345B-TAV		
1340 D CA	10	380	100	2.650	6	360	1199D	M12	
1340 I CA	10	380	100	2.650	6	360	1199D	M12	
1341 D CA	12	260	65	1.300	12	720	1199D	M12	
1341 I CA	12	260	65	1.300	12	720	1199D	M12	
2369-1 D CA	8	270	100	1.250	12	660	1199D	M12	
2369-1 I CA	8	270	100	1.250	12	660	1199D	M12	50
1345B-TAV				745		1.000			

1833-1



1342-B



1340



1341



2369



CONJUNTO CHARRUA CHISEL

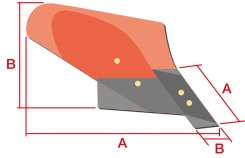

1424

Ref.	↔	A	B		M	Grs.		
1424-40 C D FORJADO						10.300	6	90
1424-40 C I FORJADO						10.300	6	90
1424-50 C D FORJADO						10.300	6	90
1424-50 C I FORJADO						10.300	6	90
1818-A D CA1	6	385	200	1199A	M10	2.070	12	324
1818-A I CA1	6	385	200	1199A	M10	2.070	12	324
1411 D CA1	8	298	90	1199A	M10	1.400	12	648
1411 I CA1	8	298	90	1199A	M10	1.400	12	648
2334 D	8	202	80	1199A	M10	800	12	720
2334 I	8	202	80	1199A	M10	800	12	720
1422-40 C D FORJADO		192	161			5.400	6	180
1422-40 C I FORJADO		192	161			5.400	6	180
1422-50 C D FORJADO		192	161			5.400	6	180
1422-50 C I FORJADO		192	161			5.400	6	180
1424-T						360		1.000

1818



1411



2334



1422



1424-T





1208

238



1218

239



1321

240



1322

241



1323

242



1324

243



1328

244



1331

245



1339

246



1347-1348

247



1366-1367

248



1371

249



1369

250



1443

251



1582-1584

252



1467

253

1

PLANTIO

2

DESCOMPACTADOR
DENTES CORVOS

3

CULTIVADOR

4

GRADE

5

CHARRUA

1208

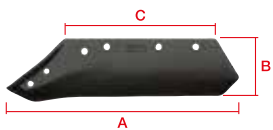

Uniformidade de produto garantido pelos estritos controlos de qualidade e o processo produtivo.



1208

Ref.	→ ←	A	B	C	Grs.			M	F
1208-7 D S.A	10	387	102	280	2.400	300			
1208-7 I S.A	10	387	102	280	2.400	300			
1208-7 D CA	10	387	102	280	2.400	250	1199A	M12	100

S.A.: sem furos.

1

PLANTIO

2

DESCOMPACTADOR
DENTES CORVOS

3

CULTIVADOR

4

GRADE

5

CHARRUA

1218

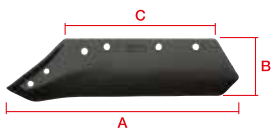

Uniformidade de produto garantido pelos estritos controlos de qualidade e o processo produtivo.



1218

Ref.		A	B	C	Grs.	
1218 D S.A	10	403	110	260	2.200	300
1218 I S.A	10	403	110	260	2.200	300

S.A.: sem furos.

1

PLANTIO

2

DESCOMPACTADOR
DENTES CORVOS

3

CULTIVADOR

4

GRADE

5

CHARRUA

1321

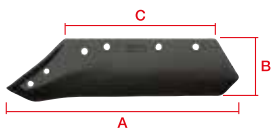

Uniformidade de produto garantido pelos estritos controlos de qualidade e o processo produtivo.



1321

Ref.		A	B	C	Grs.	
1321-1 D S.A	11	406	119	285	3.000	200
1321-1 I S.A	11	406	119	285	3.000	200

S.A.: sem furos.

1

PLANTIO

2

DESCOMPACTADOR
DENTES CORVOS

3

CULTIVADOR

4

GRADE

5

CHARRUA

1322

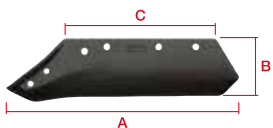

Uniformidade de produto garantido pelos estritos controlos de qualidade e o processo produtivo.



1322

Ref.		A	B	C	Grs.				M	F
1322-32 D CA3	12	585	144	410	5.950		100	1199A	M12	100
1322-32 I CA3	12	585	144	410	5.950		100	1199A	M12	100
1322-5 D S.A	13	570	153	385	6.500	6	144			100
1322-5 I S,A	13	570	153	385	6.500	6	144			100

S.A.: sem furos.

1

PLANTIO

2

DESCOMPACTADOR
DENTES CORVOS

3

CULTIVADOR

4

GRADE

5

CHARRUA

1323

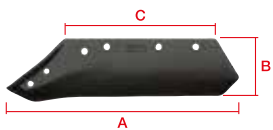

Uniformidade de produto garantido pelos estritos controlos de qualidade e o processo produtivo.



1323

Ref.	→ ←	A	B	C	Grs.			M	F
1323 D S.A	8	422	95	310	2.000	300	1199A	M12	100
1323 I S.A	8	422	95	310	2.000	300	1199A	M12	100
1323 D CA	8	422	95	310	2.000	250	1199A	M12	100
1323 I CA	8	422	95	310	2.000	250	1199A	M12	100

S.A.: sem furos.

1

PLANTIO

2

DESCOMPACTADOR
DENTES CORVOS

3

CULTIVADOR

4

GRADE

5

CHARRUA

1324

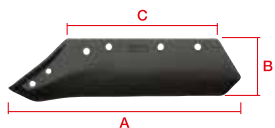

Uniformidade de produto garantido pelos estritos controlos de qualidade e o processo produtivo.



1324

Ref.		A	B	C	Grs.				M	F
1324-1 D S.A	8	359	99	275	1.800		300	1199A	M12	100
1324-1 I S.A	8	359	99	275	1.800		300	1199A	M12	100
1324-1 D CA	8	359	99	275	1.800		300	1199A	M12	
1324-1 I CA	8	359	99	275	1.800		300	1199A	M12	
1324-2 D S.A	10	388	108	295	2.500	6	360	1199A	M12	100
1324-2 D CA	10	388	108	295	2.500	6	360	1199A	M12	100

S.A.: sem furos.

1

PLANTIO

2

DESCOMPACTADOR
DENTES CORVOS

3

CULTIVADOR

4

GRADE

5

CHARRUA

1328

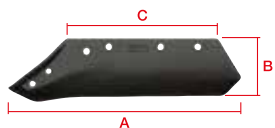

Uniformidade de produto garantido pelos estritos controlos de qualidade e o processo produtivo.



1328

Ref.		A	B	C	Grs.		F
1328-11 D S.A	11	373	120	245	2.800	420	100
1328-11 I S.A	11	373	120	245	2.800	420	100
1328-12 D S.A	11	413	130	275	3.200	300	100
1328-12 I S.A	11	413	130	275	3.200	300	100
1328-13 D S.A	11	448	135	305	3.600	200	
1328-13 I S.A	11	448	135	305	3.600	200	
1328-14 D S.A	11	483	140	335	4.000	180	
1328-14 I S.A	11	483	140	335	4.000	180	
1328-16 D S.A	12	560	140	410	5.000	150	
1328-16 I S.A	12	560	140	410	5.000	150	

S.A.: sem furos.

1

PLANTIO

2

DESCOMPACTADOR
DENTES CORVOS

3

CULTIVADOR

4

GRADE

5

CHARRUA

1331

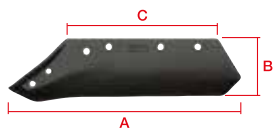

Uniformidade de produto garantido pelos estritos controlos de qualidade e o processo produtivo.



1331

Ref.	→ ←	A	B	C	Grs.		M	F
1331 D CA	8	225	75	155	1.000	900	M10	100
1331 I CA	8	225	75	155	1.000	900	M10	100

T: parafuso cabeça embutida com um perno.

1

PLANTIO

2

DESCOMPACTADOR
DENTES CORVOS

3

CULTIVADOR

4

GRADE

5

CHARRUA

1339

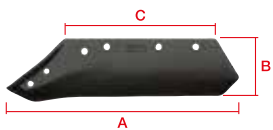

Uniformidade de produto garantido pelos estritos controlos de qualidade e o processo produtivo.



1339

Ref.		A	B	C	Grs.			M
1339-2 D CA	12	590	128	390	5.850	120	1199A	M12

1

PLANTIO

2

DESCOMPACTADOR
DENTES CORVOS

3

CULTIVADOR

4

GRADE

5

CHARRUA

1347-1348

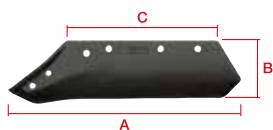

Uniformidade de produto garantido pelos estritos controlos de qualidade e o processo produtivo.

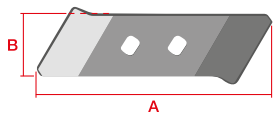

1347

Ref.	→ ←	A	B	C	Grs.			M	F
1347-32 D CA5	12	552	144	410	5.400	125	1199C	M14	100
1347-32 I CA5	12	552	144	410	5.400	125	1199C	M14	100
1348 D CA3	14	300	70		1.775	500	1199D	M12	
1348 I CA3	14	300	70		1.775	500	1199D	M12	

1348



1

PLANTIO

2

DESCOMPACTADOR
DENTES CORVOS

3

CULTIVADOR

4

GRADE

5

CHARRUA

1366-1367

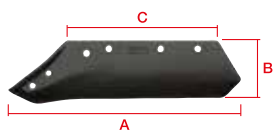

Uniformidade de produto garantido pelos estritos controlos de qualidade e o processo produtivo.

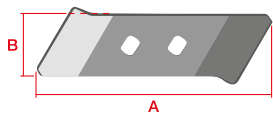

1366

Ref.	→ ←	A	B	C	Grs.			M	F
1366-16 D CA	14	655	144	455	7.100	100	1199C	M14	100
1366-16 I CA	14	655	144	455	7.100	100	1199C	M14	100
1367 D	14	278	70		1.460	500	1199D	M12	
1367 I	14	278	70		1.460	500	1199D	M12	

1367



1

PLANTIO

2

DESCOMPACTADOR
DENTES CORVOS

3

CULTIVADOR

4

GRADE

5

CHARRUA

1371

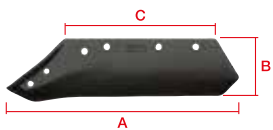

Uniformidade de produto garantido pelos estritos controlos de qualidade e o processo produtivo.



1371

Ref.		A	B	C	Grs.			M	F
1371-3 D CA1	11	525	155	300	4.100	240	1199A	M12	100
1371-3 I CA1	11	525	155	300	4.100	240	1199A	M12	100

1

PLANTIO

2

DESCOMPACTADOR
DENTES CORVOS

3

CULTIVADOR

4

GRADE

5

CHARRUA

1369

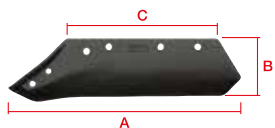

Uniformidade de produto garantido pelos estritos controlos de qualidade e o processo produtivo.



1369

Ref.		A	B	C	Grs.			M	F
1369 D CA	8	350	105	260	1.800	500	1199B	M10	100

1

PLANTIO

2

DESCOMPACTADOR
DENTES CORVOS

3

CULTIVADOR

4

GRADE

5

CHARRUA

1443

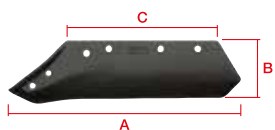

Uniformidade de produto garantido pelos estritos controlos de qualidade e o processo produtivo.



1443-PED-CA-1

Ref.		A	B	C	Grs.				M	F
1443 PED CA1	10,5	550	128	405	4.550		150	1199A	M12	100

1443-16



1582-1584



Uniformidade de produto garantido pelos estritos controles de qualidade e o processo produtivo.



1582 D & I

Ref.	→ ←	Grs.	A	B	C	D			M
1582 D	8	1.035	119	285	50	220	750	1199B	M12
1582 I	8	1.035	119	285	50	220	750	1199B	M12
1582 D CA1	8	1.035	119	285	50		750	1199B	M10
1582 I CA1	8	1.035	119	285	50		750	1199B	M10
1584 D	10	1.825	135	344	50		450	1199B	M12
1584 I	10	1.825	135	344	50		450	1199B	M12

1584-D



1467



Uniformidade de produto garantido pelos estritos controlos de qualidade e o processo produtivo.



1467-B

Ref.		A	B	Grs.		F
1467-A	10	3000	60	12.545	50	50
1467-B	10	550	60	2.300	350	50

STD: sem tratamento.

1

PLANTIO

2

DESCOMPACTADOR
DENTES CORVOS

3

CULTIVADOR

4

GRADE

5

CHARRUA



1

PLANTIO

2

DESCOMPACTADOR
DENTES CORVOS

3

CULTIVADOR

4

GRADE

5

CHARRUA

1753

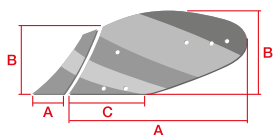

Dureza: 50 ± 2 HRC,
exceto no producto
SEMI.



1753

Ref.	$\rightarrow \leftarrow$	A	B	C	Grs.	M
1753-2 D	7	680	350	230	10.450	M12
1753-2 I	7	680	350	230	10.450	M12
1753-3 D SEMI	7	730	380	250	11.360	
1753-3 I SEMI	7	730	380	250	11.360	
1753-3 D	7	730	380	250	11.360	M12
1753-3 I	7	730	380	250	11.360	M12

SEMI: servem-se sem furos e sem tratamento para facilitar a furação.

1

PLANTIO

2

DESCOMPACTADOR
DENTES CORVOS

3

CULTIVADOR

4

GRADE

5

CHARRUA

1769

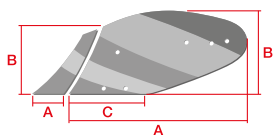

Dureza: 50 ± 2 HRC,
exceto no producto
SEMI.



1769

Ref.	\rightarrow \leftarrow	A	B	C	Grs.	F
1769-1 D SEMI	7	550	245	270	5.280	63
1769-1 I SEMI	7	550	245	270	5.280	63
1769-2 D SEMI	7	616	285	295	6.500	28

SEMI: servem-se sem furos e sem tratamento para facilitar a furação.

1

PLANTIO

2

DESCOMPACTADOR
DENTES CORVOS

3

CULTIVADOR

4

GRADE

5

CHARRUA

1781

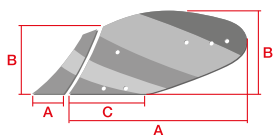

Dureza: 50 ± 2 HRC,
exceto no producto
SEMI.



1781

Ref.	$\rightarrow \leftarrow$	A	B	C	Grs.	F
1781-4 D SEMI	7	900	430	425	14.300	26

SEMI: servem-se sem furos e sem tratamento para facilitar a furação.

1

PLANTIO

2

DESCOMPACTADOR
DENTES CORVOS

3

CULTIVADOR

4

GRADE

5

CHARRUA

1786

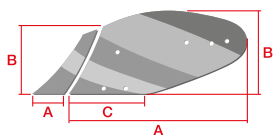

Dureza: 50 ± 2 HRC,
exceto no producto
SEMI.



1786

Ref.	$\rightarrow \leftarrow$	A	B	C	Grs.	M	F
1786-3 D	7	1055	445	470	16.540	M10	21
1786-3 I	7	1055	445	470	16.540	M10	21

1

PLANTIO

2

DESCOMPACTADOR
DENTES CORVOS

3

CULTIVADOR

4

GRADE

5

CHARRUA

1792

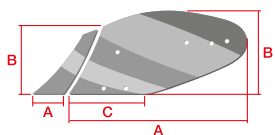

Dureza: 50 ± 2 HRC,
exceto no producto
SEMI.



1792

Ref.		A	B	C	Grs.		M	F
1792-1 D CA1	8	835	460	178	15.680	1199A	M11	24
1792-1 I CA1	8	835	460	178	15.680	1199A	M11	24
1792-1 D CA2	8	835	460	178	15.680	1199A	M11	24
1792-1 I CA2	8	835	460	178	15.680	1199A	M11	24

O modelo CA2 não possui o agulheiro central.

1

PLANTIO

2

DESCOMPACTADOR
DENTES CORVOS

3

CULTIVADOR

4

GRADE

5

CHARRUA

1788

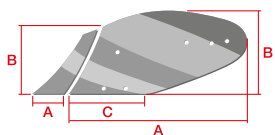

Dureza: 50 ±2 HRC,
exceto no producto
SEMI.



1788

Ref.	→ ←	A	B	C	Grs.		M	F
1788-2 F D	7	840	375	385	12.120	1199B	M14	26
1788-2 F I	7	840	375	385	12.120	1199B	M14	26

1

PLANTIO

2

DESCOMPACTADOR
DENTES CORVOS

3

CULTIVADOR

4

GRADE

5

CHARRUA

BALESTRA KVERNELAND 12500



Pintura epoxi com protecção UVA.

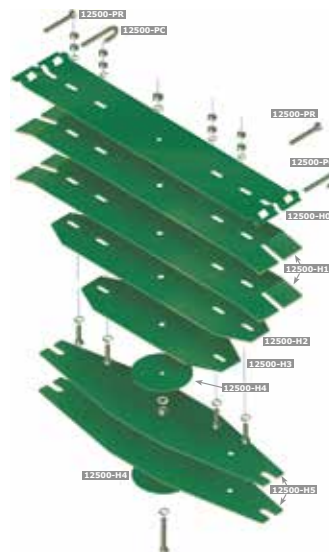

KVERNELAND 12500

Ref.	Ref. Original	→ ←	A	B	Grs.		M
12500-5	050706	4	770	170	16.500	20	M10 / 12
12500-7	060703	4	770	170	22.100	18	M10 / 12
12500-H0	057063	4	770	140	3.500	100	
12500-H1	057064	4	760	140	3.400	250	
12500-H2	057065	4	625	140	2.800	300	
12500-H3	057066	4	440	140	2.000	300	
12500-H4	057067	4	700	140	700	200	
12500-H5	057068	4		170	2.800	200	
12500-PC					373	500	
12500-PR					306	500	

12500-5 = 12500-H0 + 12500-H1 (2) + 12500-H2 + 12500-H3 + 12500-H4 (2).

12500-7 = 12500-H0 + 12500-H1 (2) + 12500-H2 + 12500-H3 + 12500-H4 (2) + 12500-H5 (2).

Distancia inicial de montagem de balestra recomendado (balestra flexionada): 70 cm (distância entre eixos).

Desenvolvem-se combinações de folhas segundo petição do cliente.

O número de lâminas por balestra dependerá das características do terreno (tipo de solo).

Composição das lâminas

Ref.	12500-H0	12500-H1	12500-H2	12500-H3	12500-H4	12500-H5
12500-5	1	2	1	1	2	
12500-7	1	2	1	1	2	2

KVERNELAND 1, 3, 5

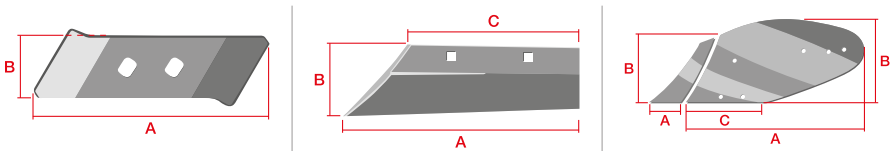
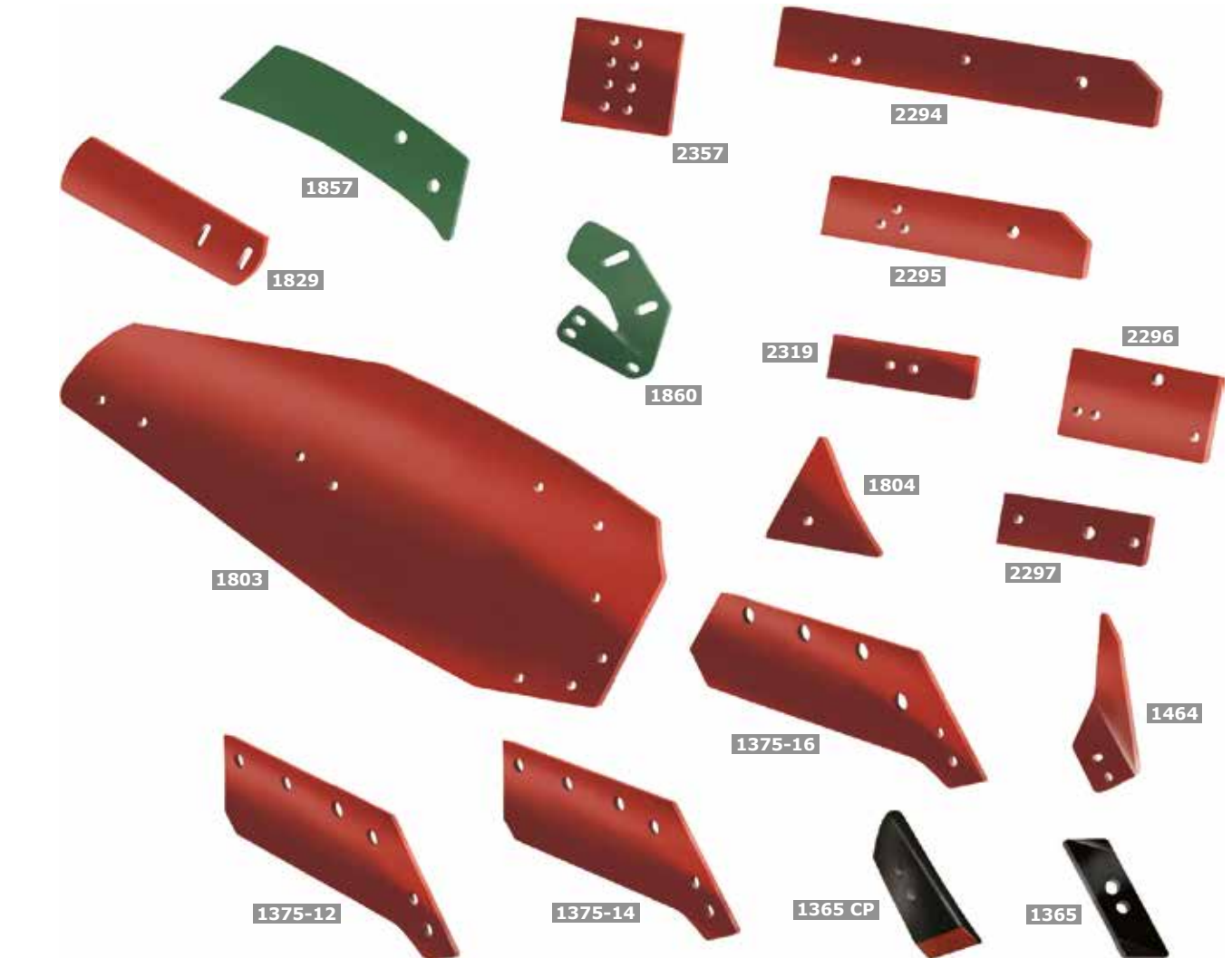

Ref.	Ref. Original	— —	A	B	C	⚙️	M	Grs.	📦	📦	F
1365-D CP DURATOP	KK053090	20	230	70	40	1199D	M12	2.100		500	
1365-I CP DURATOP	KK063090	20	230	70	40	1199D	M12	2.100		500	
1365 D CG	KK053090	12	258,5	65		1199D	M12	1.345		500	
1365 I CG	KK063090	12	258,5	65		1199D	M12	1.345		500	
1365-15 D CA CG	KK053090	15	258,5	65		1199D	M12	1.675		500	
1365-15 I CA CG	KK063090	15	258,5	65		1199D	M12	1.675		500	
1375-12 D	KK063013	11	501	142	370	1199D	M12	4.600		150	100
1375-12 I	KK063016	11	501	142	370	1199D	M12	4.600		150	100
1375-14 D	KK063014	11	501	142	370	1199D	M12	4.700		150	
1375-14 I	KK063017	11	501	142	370	1199D	M12	4.700		150	
1375-16 D	KK063015	11	563	142	370	1199D	M12	5.300		150	
1375-16 I	KK063018	11	563	142	370	1199D	M12	5.300		150	
1464 D	KK073091	4,5	283	145		1199D		830		500	
1464 I	KK073092	4,5	283	145		1199D		830		500	
1803-A D BO	KK063283-Nº3	8	1050	430	208	1199B	M12	19.657			
1803-A D TX	KK063283-Nº3	7	1050	430	208	1199B	M12	17.185			18
1803-A I BO	KK063293-Nº3	8	1050	430	208	1199B	M12	19.657			
1803-A I TX	KK063293-Nº3	7	1050	430	208	1199B	M12	17.185			18
1803-A D P	KK063283-Nº3	8	1050	430	208	1199B	M12	19.657			20
1803-A I P	KK063293-Nº3	8	1050	430	208	1199B	M12	19.657			20
1804 D BO	KK063240-Nº1,3,5	8	201	185		1199B	M12	1.029	12	900	
1804 D TX	KK063240-Nº1,3,5	7	201	185		1199B	M12	900	12	1.080	50
1804 I BO	KK063250-Nº1,3,5	8	201	185		1199B	M12	1.029	12	900	
1804 I TX	KK063250-Nº1,3,5	7	201	185		1199B	M12	900	12	1.080	50
1829 D	KK053387	8	365	100		1199B	M12	1.900	12	432	
1829 I	KK063388	8	365	100		1199B	M12	1.900	12	432	
1857 D	KK073300	8	460	150		1199B	M12	3.285		150	
1857 I	KK073301	8	460	150		1199B	M12	3.285		150	
1860 D	KK073310	10	220	200		1199B	M12	2.150		300	
1860 I	KK073311	10	220	200		1199B	M12	2.150		300	
2294 D	KK063603	10	650	105		1199C/1199D	M17/M13	6.250		150	
2294 I	KK063604	10	650	105		1199C/1199D	M17/M13	6.250		150	
2295 D	KK063605/615	10	450	105		1199C/1199D	M17/M13	4.300		200	
2295 I	KK063606	10	450	105		1199C/1199D	M17/M13	4.300		200	
2296 D	KK063607	10	250	150		1199C	M16	2.800		200	
2297 D	KK063608	12	250	85		1199C	M16	1.600		400	50
2297 I	KK063609	12	250	85		1199C	M16	1.600		400	50
2319	KK063600A	12	240	70		1199D	M12	1.400		500	
2357	KK063601A	12	214	180		1199D	M16	3.150		300	

KVERNELAND 6, 7, 8, 9

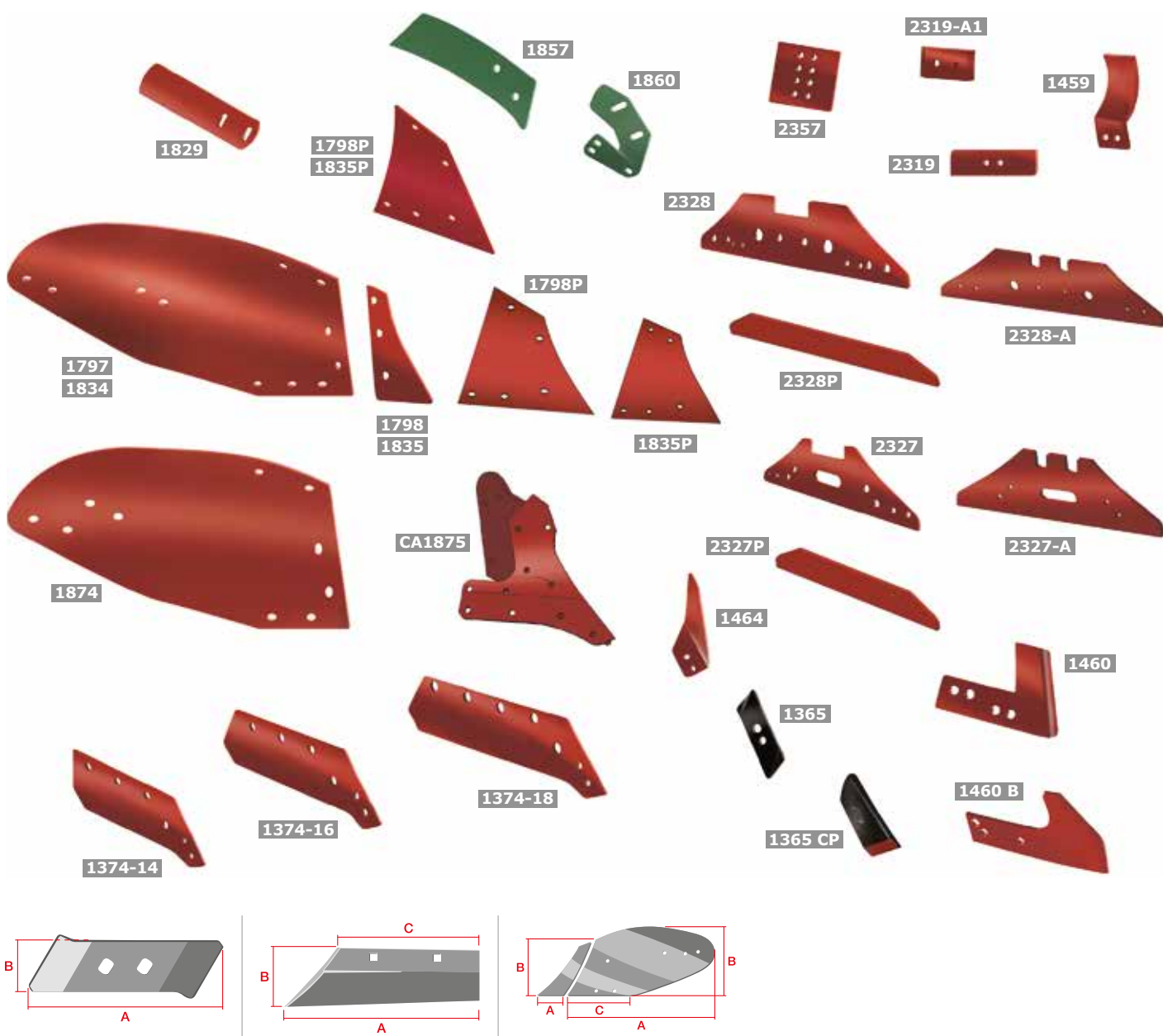

1 PLANTIO
2 DESCOMPACTADOR DENTES CURVOS
3 CULTIVADOR
4 GRADE
5 CHARRUA

Ref.	Ref. Original	— —	A	B	C	⚙	M	Grs.	📦	📦	F
1365-D CP DURATOP	KK053090	20	230	70	40	1199D	M12	2.100		500	
1365-I CP DURATOP	KK063090	20	230	70	40	1199D	M12	2.100		500	
1365 D CG	KK053090	12	258,5	65		1199D	M12	1.345		500	
1365 I CG	KK063090	12	258,5	65		1199D	M12	1.345		500	
1365-15 D CA CG	KK053090	15	258,5	65		1199D	M12	1.675		500	
1365-15 I CA CG	KK063090	15	258,5	65		1199D	M12	1.675		500	
1374-14 D CG	KK073002	11	501	142	370	1199C	M14	4.700		150	
1374-14 I CG	KK073003	11	501	142	370	1199C	M14	4.700		150	
1374-16 D CG	KK073004	11	563	142	370	1199C	M14	5.300		150	
1374-16 I CG	KK073005	11	563	142	370	1199C	M14	5.300		150	
1374-18 D CG	KK073006	11	641	142	450	1199C	M14	6.300		125	
1374-18 I CG	KK073007	11	641	142	450	1199C	M14	6.300		125	
1459 D	KK073615	10	114	200		1199C	M14	2.700		150	100
1459 I	KK073616	10	114	200		1199C	M14	2.700		150	100
1460 D	KK073088	10	357	240		1199B	M16	3.450		200	
1460 I	KK073089	10	357	240		1199B	M16	3.450		200	
1460 BD	KK084320	8	390	216		1199B	M4-M16	2.900		200	
1460 BI	KK084321	8	390	216		1199B	M4-M16	2.900		200	
1464 D	KK073091	4,5	283	145		1199D		830		500	
1464 I	KK073092	4,5	283	145		1199D		830		500	
1797-A D BO	KK073286-Nº8	8	1059	477	222	1199B	M12	20.900			
1797-A I BO	KK073287-Nº8	8	1059	477	222	1199B	M12	20.900			
1797-A D C P	KK073286-Nº8	8	1054	440	222	1199B	M12	20.900			36
1797-A I C P	KK073287-Nº8	8	1054	440	222	1199B	M12	20.900			36
1798 D BO	KK073250-Nº7,8,28	8	162	278		1199B	M12	1.500	12	648	
1798 I BO	KK073251-Nº7,8,28	8	162	278		1199B	M12	1.500	12	648	
1798-10 D CA	KK073250-Nº 7,8,28	10	162	275		1199B	M12	1.800		500	50
1798-10 I CA	KK073251-Nº7,8,28	10	162	275		1199B	M12	1.800		500	50
1798 D PROTECTOR		7	374	325		1199B	M12	3.600		150	
1798 I PROTECTOR		7	374	325		1199B	M12	3.600		150	
1829 D	KK053387	8	365	100		1199B	M12	1.900	12	432	
1829 I	KK063388	8	365	100		1199B	M12	1.900	12	432	
1834 D BO	KK073290-Nº9	8	980	440	280	1199B	M12	20.700			
1834 I BO	KK073291-Nº9	8	980	440	280	1199B	M12	20.700			
1835 D BO	KK073256-Nº6-9	8	166	325		1199B	M12	1.600	12	540	
1835 I BO	KK073257-Nº6-9	8	166	325		1199B	M12	1.600	12	540	
1835 D PROTECTOR		7	386	363		1199B	M12	4.260		150	
1835 I PROTECTOR		7	386	363		1199B	M12	4.260		150	
1857 D	KK073300	8	460	150		1199B	M12	3.285		150	
1857 I	KK073301	8	460	150		1199B	M12	3.285		150	
1860 D	KK073310	10	220	200		1199B	M12	2.150		300	
1860 I	KK073311	10	220	200		1199B	M12	2.150		300	
1874 D	KK073260-Nº6	8	780	395	200	1199B	M12	14.150			
1874 I	KK073261-Nº6	8	780	395	200	1199B	M12	14.150			
1875 D	KKNº 6,9	10	397	380				6.500		120	
1875 I	KKNº 6,9	10	397	380				6.500		120	
CA1875 D KV8	KKNº 6,7,8,9,28	10/12						11.600			
CA1875 I KV8	KKNº 6,7,8,9,28	10/12						11.600			
2319	KK063600A	12	240	70		1199D	M12	1.400		500	
2319-A1	KK073614	12	145	80		1199C	M14	1.000		800	
2327	KK073608	11	566	170		1199C	M14	5.250		150	
2327-A	KK073608	11	566	170		1199C	M14	5.200	50	150	50
2327 PROTECTOR		12	566	90		1199C	M14	4.200		200	
2328	KK073609	11	746	170		1199C	M14	7.900		100	
2328-A	KK073609	11	746	170		1199C	M14	7.850		100	50
2328 PROTECTOR		12	746	90		1199C	M14	5.750		150	
2357	KK063601A	12	214	180		1199D	M16	3.150		300	

KVERNELAND 12, 15, 19

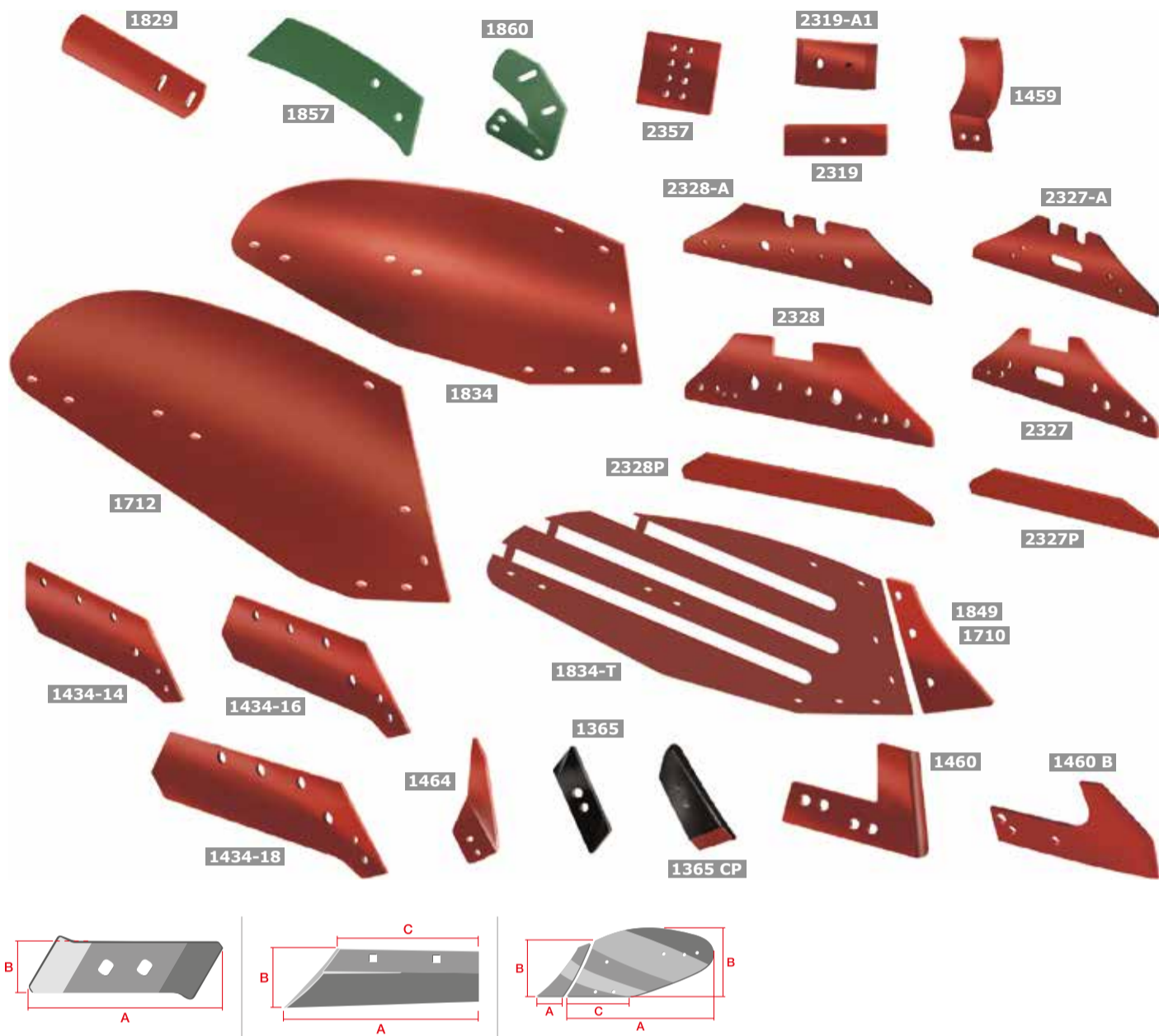

Ref.	Ref. Original	— —	A	B	C	⚙	M	Gr.	📦	📦	F
1365-D CP DURATOP	KK053090	20	230	70	40	1199D	M12	2.100		500	
1365-I CP DURATOP	KK063090	20	230	70	40	1199D	M12	2.100		500	
1365 D CG	KK053090	12	258,5	65		1199D	M12	1.345		500	
1365 I CG	KK063090	12	258,5	65		1199D	M12	1.345		500	
1365-15 D CA CG	KK053090	15	258,5	65		1199D	M12	1.675		500	
1365-15 I CA CG	KK063090	15	258,5	65		1199D	M12	1.675		500	
1434-14 D	KK073054	11	484	144	370	1199C	M14	5.060		150	100
1434-14 I	KK073055	11	484	144	370	1199C	M14	5.060		150	100
1434-16 D	KK073056	11	549	144	380	1199C	M14	5.260		150	
1434-16 I	KK073057	11	549	144	380	1199C	M14	5.260		150	
1434-18 D	KK073080	11	635	145	465	1199C	M14	6.240		100	
1434-18 I	KK073081	11	635	145	465	1199C	M14	6.240		100	
1459 D	KK073615	10	114	200		1199C	M14	2.700		150	100
1459 I	KK073616	10	114	200		1199C	M14	2.700		150	100
1460 D	KK073088	10	357	240		1199B	M16	3.450		200	
1460 I	KK073089	10	357	240		1199B	M16	3.450		200	
1460 BD	KK084320	8	390	216		1199B	M4-M16	2.900		200	
1460 BI	KK084321	8	390	216		1199B	M4-M16	2.900		200	
1464 D	KK073091	4,5	283	145		1199D		830		500	
1464 I	KK073092	4,5	283	145		1199D		830		500	
1710 D CA	KK073227-Nº15	8	165	410		1199B	M12	2.620		500	50
1710 I CA	KK073228-Nº15	8	165	410		1199B	M12	2.620		500	50
1712 D CA	KK073224-Nº15	8	825	540	200	1199B	M12	18.820			20
1712 I CA	KK073225-Nº15	8	825	540	200	1199B	M12	18.820			20
1829 D	KK053387	8	365	100		1199B	M12	1.900	12	432	
1829 I	KK063388	8	365	100		1199B	M12	1.900	12	432	
1834 D BO	KK073290-Nº9	8	980	440	280	1199B	M12	20.700			
1834 I BO	KK073291-Nº9	8	980	440	280	1199B	M12	20.700			
1834 D T	Nº9	8	980	440	280	1199B	M12	15.750			18
1834 I T	Nº9	8	980	440	280	1199B	M12	15.750			18
1834 D PROTECTOR		7	217	363		1199B	M12	2.670		330	50
1834 I PROTECTOR		7	217	363		1199B	M12	2.670		330	50
1849 D	KK073230-Nº19	8	160	325		1199B	M12	1.800		400	
1849 I	KK073231-Nº19	8	160	325		1199B	M12	1.800		400	
1849-12 D		12	160	325		1199B	M12	2.810		330	
1849-12 I		12	160	325		1199B	M12	2.810		330	
1857 D	KK073300	8	460	150		1199B	M12	3.285		150	
1857 I	KK073301	8	460	150		1199B	M12	3.285		150	
1860 D	KK073310	10	220	200		1199B	M12	2.150		300	
1860 I	KK073311	10	220	200		1199B	M12	2.150		300	
2319	KK063600A	12	240	70		1199D	M12	1.400		500	
2319-A1	KK073614	12	145	80		1199C	M14	1.000		800	
2327	KK073608	11	566	170		1199C	M14	5.250		150	
2327-A	KK073608	11	566	170		1199C	M14	5.200	50	150	50
2327 PROTECTOR		12	566	90		1199C	M14	4.200		200	
2328	KK073609	11	746	170		1199C	M14	7.900		100	
2328-A	KK073609	11	746	170		1199C	M14	7.850		100	50
2328 PROTECTOR		12	746	90		1199C	M14	5.750		150	
2357	KK063601A	12	214	180		1199D	M16	3.150		300	

KVERNELAND 28

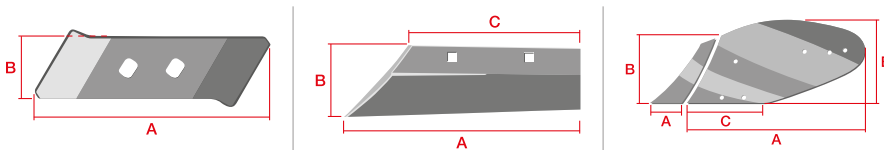
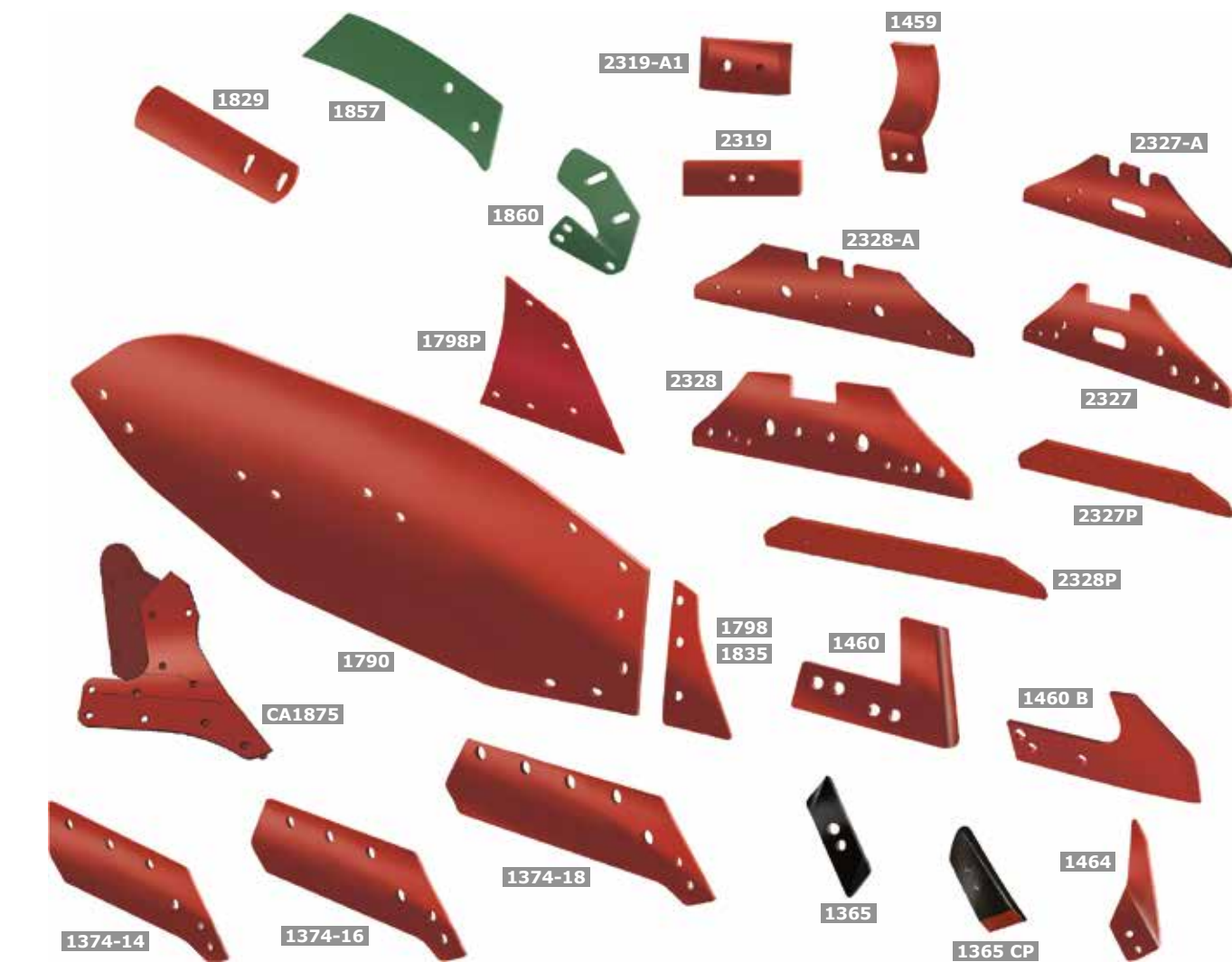

Ref.	Ref. Original	— —	A	B	C	⚙️	M	Grs.	📦	📦	F
1365-D CP DURATOP	KK053090	20	230	70	40	1199D	M12	2.100		500	
1365-I CP DURATOP	KK063090	20	230	70	40	1199D	M12	2.100		500	
1365 D CG	KK053090	12	258,5	65		1199D	M12	1.345		500	
1365 I CG	KK063090	12	258,5	65		1199D	M12	1.345		500	
1365-15 D CA CG	KK053090	15	258,5	65		1199D	M12	1.675		500	
1365-15 I CA CG	KK063090	15	258,5	65		1199D	M12	1.675		500	
1374-14 D CG	KK073002	11	501	142	370	1199C	M14	4.700		150	
1374-14 I CG	KK073003	11	501	142	370	1199C	M14	4.700		150	
1374-16 D CG	KK073004	11	563	142	370	1199C	M14	5.300		150	
1374-16 I CG	KK073005	11	563	142	370	1199C	M14	5.300		150	
1374-18 D CG	KK073006	11	641	142	450	1199C	M14	6.300		125	
1374-18 I CG	KK073007	11	641	142	450	1199C	M14	6.300		125	
1459 D	KK073615	10	114	200		1199C	M14	2.700		150	100
1459 I	KK073616	10	114	200		1199C	M14	2.700		150	100
1460 D	KK073088	10	357	240		1199B	M16	3.450		200	
1460 I	KK073089	10	357	240		1199B	M16	3.450		200	
1460 BD	KK084320	8	390	216		1199B	M4-M16	2.900		200	
1460 BI	KK084321	8	390	216		1199B	M4-M16	2.900		200	
1464 D	KK073091	4,5	283	145		1199D		830		500	
1464 I	KK073092	4,5	283	145		1199D		830		500	
1790-D BO	KK083228	8	1185	450	285	1199B	M12	24.390			14
1790-I BO	KK083229	8	1185	450	285	1199B	M12	24.390			14
1798 D BO	KK073250-Nº7,8,28	8	162	278		1199B	M12	1.500	12	648	
1798 I BO	KK073251-Nº7,8,28	8	162	278		1199B	M12	1.500	12	648	
1798-10 D CA	KK073250-Nº 7,8,28	10	162	275		1199B	M12	1.800		500	50
1798-10 I CA	KK073251-Nº7,8,28	10	162	275		1199B	M12	1.800		500	50
1798 D PROTECTOR		7	374	325		1199B	M12	3.600		150	
1798 I PROTECTOR		7	374	325		1199B	M12	3.600		150	
1829 D	KK053387	8	365	100		1199B	M12	1.900	12	432	
1829 I	KK063388	8	365	100		1199B	M12	1.900	12	432	
1860 D	KK073310	10	220	200		1199B	M12	2.150		300	
1860 I	KK073311	10	220	200		1199B	M12	2.150		300	
CA1875 D KV8	KKNº 6,7,8,9,28	10/12						11.600			
CA1875 I KV8	KKNº 6,7,8,9,28	10/12						11.600			
2319	KK063600A	12	240	70		1199D	M12	1.400		500	
2319-A1	KK073614	12	145	80		1199C	M14	1.000		800	
2327	KK073608	11	566	170		1199C	M14	5.250		150	
2327-A	KK073608	11	566	170		1199C	M14	5.200	50	150	50
2327 PROTECTOR		12	566	90		1199C	M14	4.200		200	
2328	KK073609	11	746	170		1199C	M14	7.900		100	
2328-A	KK073609	11	746	170		1199C	M14	7.850		100	50
2328 PROTECTOR		12	746	90		1199C	M14	5.750		150	

KVERNELAND 30

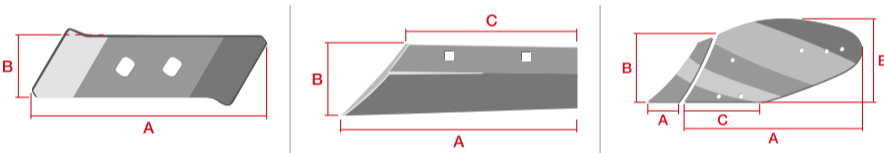
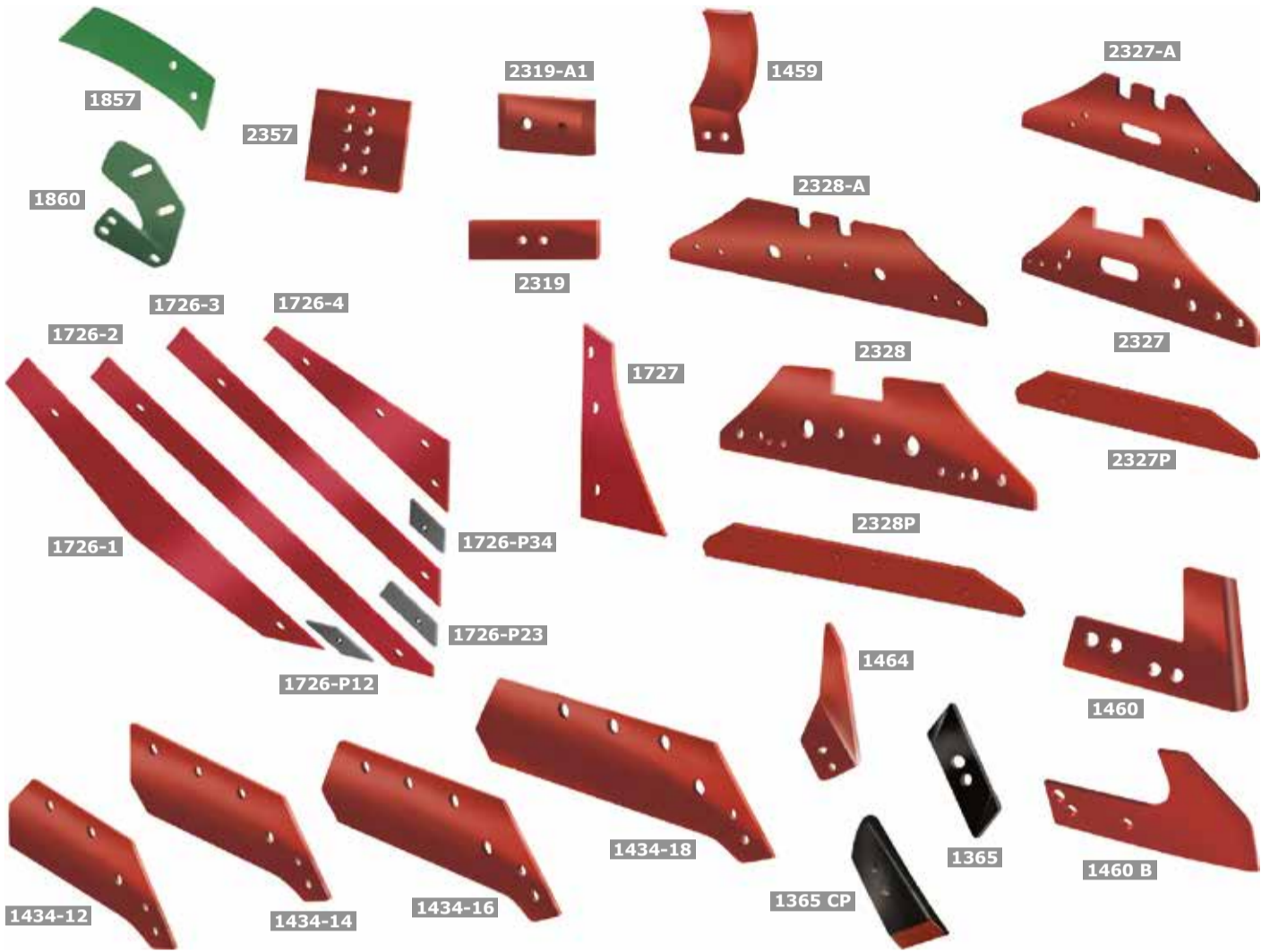

Ref.	Ref. Original	±	A	B	C	⚙	M	Gr.	📦	📦	F
1365-D CP DURATOP	KK053090	20	230	70	40	1199D	M12	2.100		500	
1365-I CP DURATOP	KK063090	20	230	70	40	1199D	M12	2.100		500	
1365 D CG	KK053090	12	258,5	65		1199D	M12	1.345		500	
1365 I CG	KK063090	12	258,5	65		1199D	M12	1.345		500	
1365-15 D CA CG	KK053090	15	258,5	65		1199D	M12	1.675		500	
1365-15 I CA CG	KK063090	15	258,5	65		1199D	M12	1.675		500	
1434-14 D	KK073054	11	484	144	370	1199C	M14	5.060		150	100
1434-14 I	KK073055	11	484	144	370	1199C	M14	5.060		150	100
1434-16 D	KK073056	11	549	144	380	1199C	M14	5.260		150	
1434-16 I	KK073057	11	549	144	380	1199C	M14	5.260		150	
1434-18 D	KK073080	11	635	145	465	1199C	M14	6.240		100	
1434-18 I	KK073081	11	635	145	465	1199C	M14	6.240		100	
1459 D	KK073615	10	114	200		1199C	M14	2.700		150	100
1459 I	KK073616	10	114	200		1199C	M14	2.700		150	100
1460 D	KK073088	10	357	240		1199B	M16	3.450		200	
1460 I	KK073089	10	357	240		1199B	M16	3.450		200	
1460 BD	KK084320	8	390	216		1199B	M4-M16	2.900		200	
1460 BI	KK084321	8	390	216		1199B	M4-M16	2.900		200	
1464 D	KK073091	4,5	283	145		1199D		830		500	
1464 I	KK073092	4,5	283	145		1199D		830		500	
1726-1 D	KK083211	12	880	110		1199B	M12	6.700		300	
1726-1 I	KK083221	12	880	110		1199B	M12	6.700		300	
1726-2 D	KK083212	12	956	60		1199B	M12	5.170		300	
1726-2 I	KK083222	12	956	60		1199B	M12	5.170		300	
1726-3 D	KK083213	12	785	60		1199B	M12	4.270		300	
1726-3 I	KK083223	12	785	60		1199B	M12	4.270		300	
1726-4 D	KK083214	12	535	115		1199B	M12	3.630		300	
1726-4 I	KK083224	12	535	115		1199B	M12	3.630		300	
1726P-12	KK083215							300		2.000	
1726P-23	KK083216							300		2.000	
1726P-34	KK083217							300		2.000	
1727 D	KK073230R	8	165	335		1199B	M12	1.790		300	50
1727 I	KK073231R	8	165	335		1199B	M12	1.790		300	50
1857 D	KK073300	8	460	150		1199B	M12	3.285		150	
1857 I	KK073301	8	460	150		1199B	M12	3.285		150	
1860 D	KK073310	10	220	200		1199B	M12	2.150		300	
1860 I	KK073311	10	220	200		1199B	M12	2.150		300	
2319	KK063600A	12	240	70		1199D	M12	1.400		500	
2319-A1	KK073614	12	145	80		1199C	M14	1.000		800	
2327	KK073608	11	566	170		1199C	M14	5.250		150	
2327-A	KK073608	11	566	170		1199C	M14	5.200	50	150	50
2327 PROTECTOR		12	566	90		1199C	M14	4.200		200	
2328	KK073609	11	746	170		1199C	M14	7.900		100	
2328-A	KK073609	11	746	170		1199C	M14	7.850		100	50
2328 PROTECTOR		12	746	90		1199C	M14	5.750		150	
2357	KK063601A	12	214	180		1199D	M16	3.150		300	

KVERNELAND ECOMAT

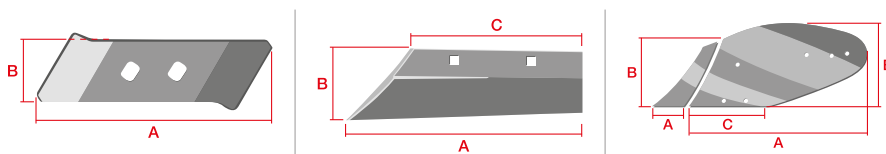

Ref.	Ref. Original	— —	A	B	C	†	M	Grs.	▨	F
1365-D CP DURATOP	KK053090	20	230	70	40	1199D	M12	2.100	500	
1365-I CP DURATOP	KK063090	20	230	70	40	1199D	M12	2.100	500	
1365 D CG	KK053090	12	258,5	65		1199D	M12	1.345	500	
1365 I CG	KK063090	12	258,5	65		1199D	M12	1.345	500	
1365-15 D CA CG	KK053090	15	258,5	65		1199D	M12	1.675	500	
1365-15 I CA CG	KK063090	15	258,5	65		1199D	M12	1.675	500	
1460 BD	KK084320	8	390	216		1199B	M4-M16	2.900	200	
1460 BI	KK084321	8	390	216		1199B	M4-M16	2.900	200	
1374-14 D CG	KK073002	11	501	142	370	1199C	M14	4.700	150	
1374-14 I CG	KK073003	11	501	142	370	1199C	M14	4.700	150	
1374-16 D CG	KK073004	11	563	142	370	1199C	M14	5.300	150	
1374-16 I CG	KK073005	11	563	142	370	1199C	M14	5.300	150	
1374-18 D CG	KK073006	11	641	142	450	1199C	M14	6.300	125	
1374-18 I CG	KK073007	11	641	142	450	1199C	M14	6.300	125	
1742 D CA6 AGUJ	KK084243	6	725	341	427			8.850	100	
1742 I CA6 AGUJ	KK084244	6	725	341	427			8.850	100	
1742 D CA7 AGUJ	KK084243	6	725	341	427			8.850	100	
1742 I CA7 AGUJ	KK084244	6	725	341	427			8.850	100	
2381	KK084234	12	174	90	110	1199C	M14	1.500	500	50

KVERNELAND HYDREIN

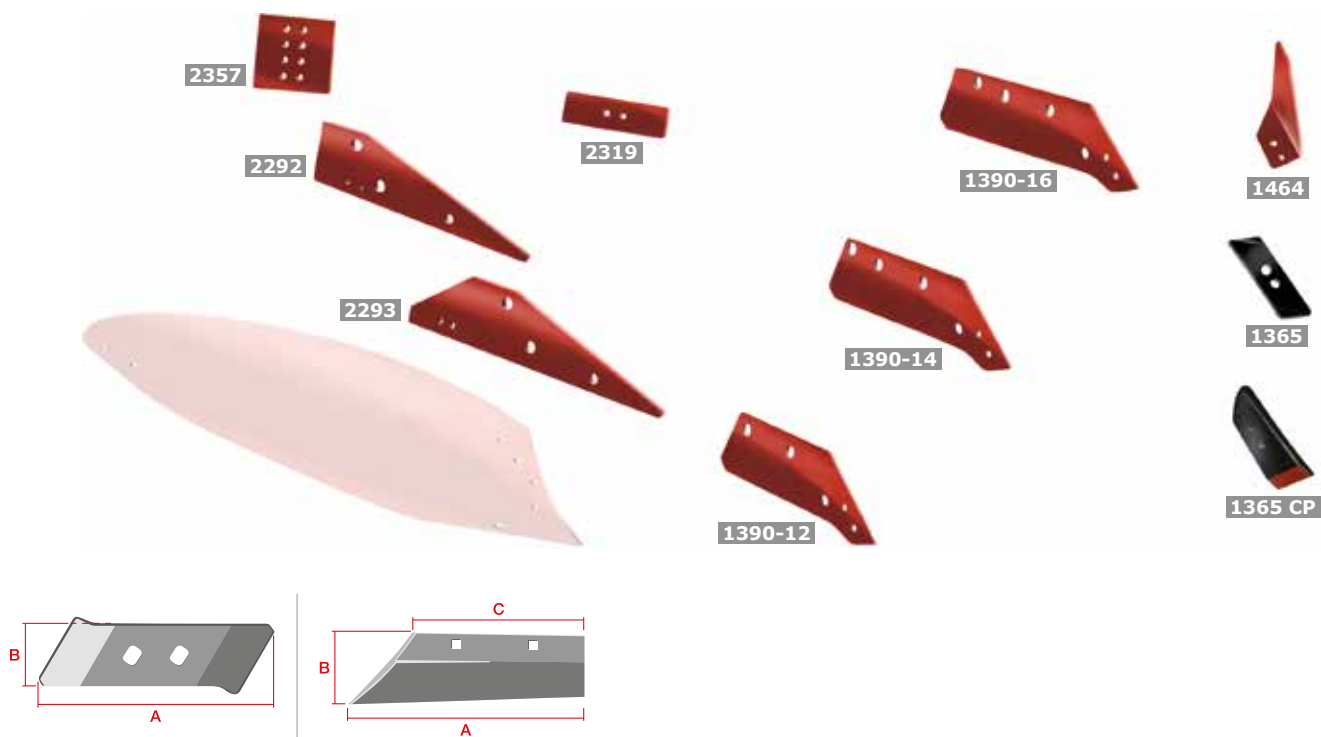

Ref.	Ref. Original	\rightarrow \leftarrow	A	B	C		M	Grs.		F
1365-D CP DURATOP	KK053090	20	230	70	40	1199D	M12	2.100	500	
1365 D CG	KK053090	12	258,5	65		1199D	M12	1.345	500	
1365-15 D CA CG	KK053090	15	258,5	65		1199D	M12	1.675	500	
1390-12 D	KK053085	11	432	144	280	1199D	M13	4.100	125	
1390-14 D	KK053087	11	500	142	350	1199D	M13	5.000	125	
1390-16 D	KK053088	11	572,5	140	400	1199D	M13	5.350	125	
1464 D	KK073091	4,5	283	145		1199D		830	500	
2319	KK063600A	12	240	70		1199D	M12	1.400	500	
2357	KK063601A	12	214	180		1199D	M16	3.150	300	
2292 D	KK053684	11	550	170		1199A	M16	5.170	150	50
2293 D	KK053683	11	735	70		1199A	M16	6.930	125	50

KVERNELAND

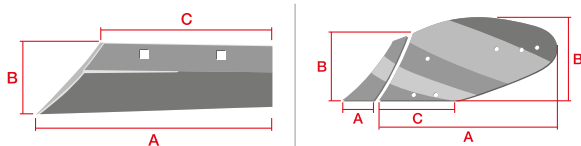
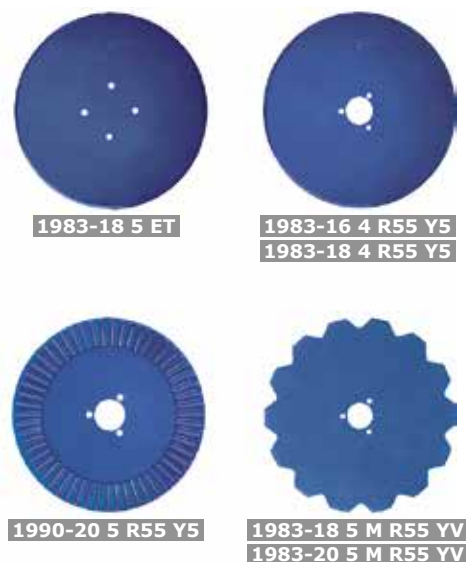
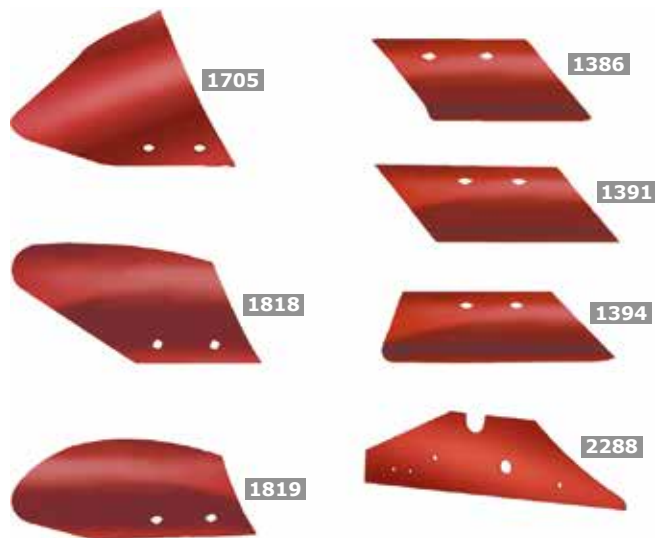

Ref.	Ref. Original	— —	A	B	C		M	Grs.			F
1386 D	KK056873	8,5	190	100	190	1199B	M10	1.050		500	
1386 I	KK066873	8,5	190	100	190	1199B	M10	1.050		500	
1391 D	KK056852	8	242	100	240	1199B	M10	1.000		400	100
1394 D	KK066868	8	330	100	210	1199B	M10	1.550		350	
1394 I	KK066869	8	330	100	210	1199B	M10	1.550		350	
1394	KK066868 / 0066869	8	350	100	172	1199B	M10	1.500		350	100
1705 D	KK076812	5	369	285	214	1199B	M10	3.000		150	
1705 I	KK076813	5	369	285	214	1199B	M10	3.000		150	
1818 D	KK066878	4	360	175		1199A	M10	1.380	12	648	
1818 I	KK066879	4	360	175		1199A	M10	1.380	12	648	
1819 D	KK066880	4	360	155		1199B	M10	1.340	12	648	
1819 I	KK066881	4	360	155		1199B	M10	1.340	12	648	
1983-16 4 R55 Y5	KK056111	4	423					4.300		50	16
1983-18 5 R55 Y5	KK056112	5	457					6.400		50	16
1990-20 5 R55 Y5	KK056114	5	508					7.900		100	16
1983-18 5 M R55 YV	KK056115	5	457					5.360		100	16
1983-20 5 M R55 YV	KK056116	5	508					6.770		100	16
1983-18 5 ET	KK076406	5	457					5.840		100	16
2288 D CA2	KK073600/073610	11	620	170		1199C	M14	6.400		150	50
2288 I CA2	KK073601/073611	11	620	170		1199C	M14	6.400		150	50
2293 D	KK053683	11	735	70		1199A	M16	6.930		125	50

KUHN 28

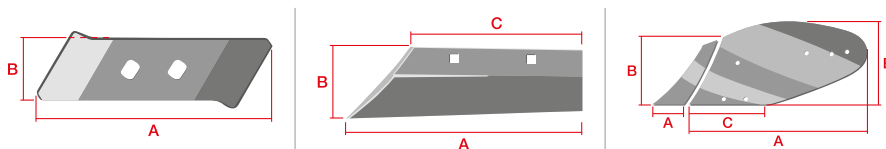
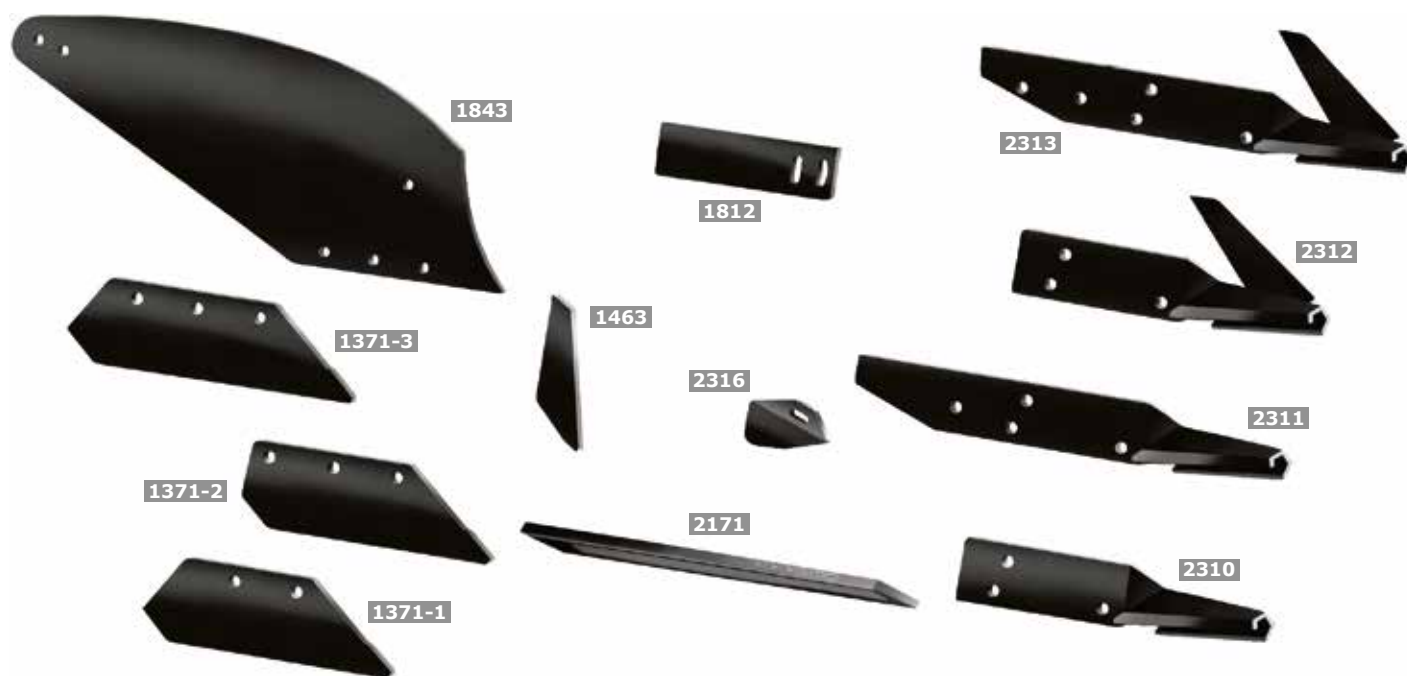

Ref.	Ref. Original		A	B	C		M	Grs.			F	Denom. part.
1371-1 D	625034	11	452	155	225	1199B	M14	3.500		200	100	
1371-1 I	625035	11	452	155	225	1199B	M14	3.500		200	100	
1371-2 D	625036/625100	11	452	155	285	1199B	M14	3.750		200	100	
1371-2 I	625037/625101	11	452	155	285	1199B	M14	3.750		200	100	
1371-3 D	625030/625102	11	525	155	305	1199B	M14	4.100		200		
1371-3 I	625031/625103	11	525	155	305	1199B	M14	4.100		200		
1463	270060	12	137	90				900		750		
1812	648005	8	320	100				1.700	12	432	50	
1843-1 D	610034	7	839	348	385	1199B	M12	10.550			33	Modelo americano Y2
1843-1 I	610035	7	839	348	385	1199B	M12	10.550			33	Modelo americano Y2
2171 28x28	460022	28	725	28				3.300		250		
2310 D	279006	10	300	110		1199B	M12	4.800		100		Curto sem alerón B,K,X
2310 I	279007	10	300	110		1199B	M12	4.800		100		Curto sem alerón B,K,X
2311 D	279008	10	525	110		1199B	M12	6.300		75		Largo sem alerón B,K,X
2311 I	279009	10	525	110		1199B	M12	6.300		75		Largo sem alerón B,K,X
2312 D	549006	10	300	110		1199B	M12	5.700		75	50	Curto com alerón B,K,X
2312 I	549007	10	300	110		1199B	M12	5.700		75	50	Curto com alerón B,K,X
2313 D	549008	10	525	110		1199B	M12	7.200		60	50	Largo com alerón B, K,X
2313 I	549009	10	525	110		1199B	M12	7.200		60	50	Largo com alerón B,K,X
2316 D	763008							2.100		300		Não reforçado
2316 I	763009							2.100		300		Não reforçado

KUHN HELICOIDAL

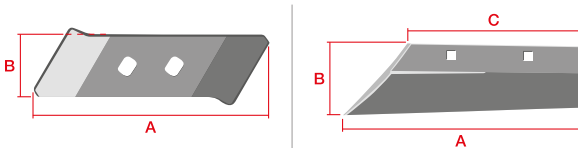

Ref.	Ref. Original	\rightarrow \leftarrow	A	B	C		M	Grs.		F	Denom. part.
1373 D	622010	12	330	70		1199B	M14	1.800	350	100	
1373 I	622011	12	330	70		1199B	M14	1.800	350	100	
1383-16 D L CA	622212	12	671	158	395	1199B	M14	6.200	100	100	Tipo L
1383-16 I L CA	622213	12	671	158	395	1199B	M14	6.200	100	100	Tipo L
1385 D	622128 MARATHON	12	300	85		1199D	M12	1.850	300		
1385 I	622129 MARATHON	12	300	85		1199D	M12	1.850	300		
1388 D	622180	10	305	85		1199D	M12	1.850	300		
1388 I	622181	10	305	85		1199D	M12	1.850	300		
1430-14 D	622166	12	570	173	375	1199B	M14	5.300	125	100	Tipo H
1430-14 I	622167	12	570	173	375	1199B	M14	5.300	125	100	Tipo H
1430-16 D	622172	12	654	173	450	1199B	M14	5.700	100		Tipo H
1430-16 I	622173	12	654	173	450	1199B	M14	5.700	100		Tipo H
1430-B-14 D	622232	12	570	173	375	1199B	M14	5.300	125	100	
1430-B-14 I	622233	12	570	173	375	1199B	M14	5.300	125	100	
1430-B-16 D	622234	12	654	173	450	1199B	M14	5.700	100	100	
1430-B-16 I	622235	12	654	173	450	1199B	M14	5.700	100	100	
1431-14 D	581140	12	570	173	375	1199B	M14	6.200	80	100	Tipo H
1431-14 I	581141	12	570	173	375	1199B	M14	6.200	80	100	Tipo H
1431-16 D	581416	12	654	173	450	1199B	M14	6.600	80	100	Tipo H
1431-16 I	581417	12	654	173	450	1199B	M14	6.600	80	100	Tipo H
1431-B-14 D	583890	12	570	173	375	1199B	M14	6.200	80	100	
1431-B-14 I	583891	12	570	173	375	1199B	M14	6.200	80	100	
1431-B-16 D	583892	12	654	173	450	1199B	M14	6.600	80	100	
1431-B-16 I	583893	12	654	173	450	1199B	M14	6.600	80	100	
1719-D	619172	8	283	322		1199B	M12	2.860	250		
1719-I	619173	8	283	322		1199B	M12	2.860	250		
1719-D PROTECTOR		8	500	354		1199B	M12	5.690	150		
1719-I PROTECTOR		8	500	354		1199B	M12	5.690	150		
1735 D	616242	7	1030	470	238	1199B	M12	18.700		22	
1735 I	616243	7	1030	470	238	1199B	M12	18.700		22	
1736 D	619178	7	270	282		1199B	M12	2.100		50	
1736 I	619179	7	270	282		1199B	M12	2.100		50	
2329	223122	10	452	110		1199D	M12	3.850	200		Reversível
2329 B	761108	10	550	110		1199D	M12	4.650	200		Reversível
2329 C	279140	10	550	130		1199D	M12	5.500	200		Reversível
2331 D	223120	10	195	110		1199D	M12	950	500	50	Tipo H4
2331 I	223121	10	195	110		1199D	M12	950	500	50	Tipo H4
2375 D	761110	10	155	108		1199D	M12	825	1.000	50	Tipo L
2375 I	761111	10	155	108		1199D	M12	825	1.000	50	Tipo L
2383 D	761216	10	165	105		1199D	M12	900	1.000	50	Tipo SK
2383 I	761217	10	165	105		1199D	M12	900	1.000	50	Tipo SK

KUHN LOSANGE

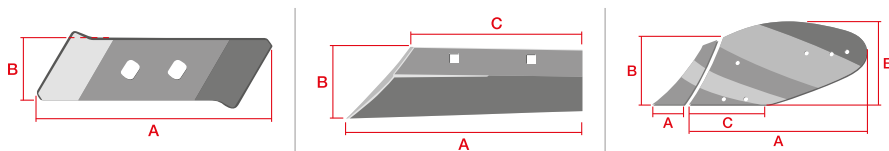

Ref.	Ref. Original	↔	A	B	C	☛	M	Grs.	📦	📏	F	Denom. part.
1384-14 D	622140	12	587	158	395	1199B	M14	5.500		100		
1384-14 I	622141	12	587	158	395	1199B	M14	5.500		100		
1384-16 D	622142	12	671	158	395	1199B	M14	6.200		100		
1384-16 I	622143	12	671	158	395	1199B	M14	6.200		100		
1385 D	622128 MARATHON	12	300	85		1199D	M12	1.850		300		
1385 I	622129 MARATHON	12	300	85		1199D	M12	1.850		300		
1385 D CP DURATOP	622164 SUPER MARATHON	22				1199D	M12	2.400		450		
1385 I CP DURATOP	622165 SUPER MARATHON	22				1199D	M12	2.400		450		
1388 D	622180	10	305	85		1199D	M12	1.850		300		
1388 I	622181	10	305	85		1199D	M12	1.850		300		
1800 D	619038	10	270	220		1199B	M12	2.180	6	462		Tipo R/RS/RH
1800 I	619039	10	270	220		1199B	M12	2.180	6	462		Tipo R/RS/RH
1811 D BO	616092/616104	7	930	375	380	1199B	M12	15.500			18	Tipo RS/RL
1811 I BO	616093/616105	7	930	375	380	1199B	M12	15.500			18	Tipo RS/RL
1812	648005	8	320	100				1.700	12	432	50	
2314 D	279028	12	225	70		1199B	M12	1.160		600		
2314 I	279029	12	225	70		1199B	M12	1.160		600		
2315 D	279030	12	650	70		1199B	M12	3.850		200		Tipo AR Largo
2315 I	279031	12	650	70		1199B	M12	3.850		200		Tipo AR Largo
2317	226104 / 226100	8	360	210		1199B	M12	4.500		200		
2330	200645	10	305	110		1199B	M12	2.500		250	50	
2364 A	279152	12	372	70		1199B	M12	2.380		400	50	Reversível
2365 D	279150	12	150	70		1199B	M12	690		1.200	50	Losange
2365 I	279151	12	150	70		1199B	M12	690		1.200	50	Losange
2366 D	761106	10	158	110		1199B	M12	880		1.200	50	Tipo HB/HC
2366 I	761107	10	158	110		1199B	M12	880		1.200	50	Tipo HB/HC
2367 D	279142	10	195	110		1199B	M14	1.140		1.000	50	Tipo BL
2367 I	279143	10	195	110		1199B	M14	1.140		1.000	50	

KUHN CLÁSSICO

1

PLANTIO

2

DESCOMPACTADOR
DENTES CORVOS

3

CULTIVADOR

4

GRADE

5

CHARRUA

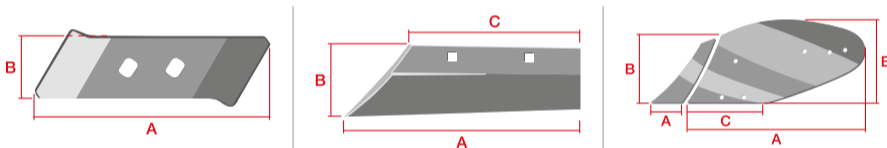

Ref.	Ref. Original		A	B	C	⚙	M	Grs.	📦	📦	F	Denom. part.
1362-3 D	620088	12	618	140	395	1199B	M14	5.350		100		Sem alerón
1362-3 I	620089	12	618	140	395	1199B	M14	5.350		100		Sem alerón
1362-2A D CA2	620090	12	543	141	305	1199B	M14	4.780		100		Sem alerón
1362-2A I CA2	620091	12	543	141	305	1199B	M14	4.780		100		Sem alerón
1383-14 D	622134	12	587	158	395	1199B	M14	5.500		100		Sem alerón
1383-14 I	622135	12	587	158	395	1199B	M14	5.500		100		Sem alerón
1383-16 D	622136	12	671	158	395	1199B	M14	6.200		100		Sem alerón
1383-16 I	622137	12	671	158	395	1199B	M14	6.200		100		Sem alerón
1385 D	622128 MARATHON	12	300	85		1199D	M12	1.850		300		
1385 I	622129 MARATHON	12	300	85		1199D	M12	1.850		300		
1385 D CP DURATOP	622164 SUPER MARATHON	22				1199D	M12	2.400		450		
1385 I CP DURATOP	622165 SUPER MARATHON	22				1199D	M12	2.400		450		
1388 D	622180	10	305	85		1199D	M12	1.850		300		
1388 I	622181	10	305	85		1199D	M12	1.850		300		
1393-14 D	580884	12	587	158	395	1199B	M14	5.500		80		Com alerón
1393-14 I	580885	12	587	158	395	1199B	M14	5.500		80		Com alerón
1393-16 D	580886	12	671	158	395	1199B	M14	6.200		80		
1393-16 I	580887	12	671	158	395	1199B	M14	6.200		80		
1463	270060	12	137	90				900		750		
1812	648005	8	320	100				1.700	12	432	50	
1843-1 D	610034	7	839	348	385	1199B	M12	10.550			33	Modelo americano Y2
1843-1 I	610035	7	839	348	385	1199B	M12	10.550			33	Modelo americano Y2
1843-2 D CA1	610032	7	941	398	385	1199B	M12	13.250			21	Modelo americano Y2
1843-2 I CA1	610033	7	941	398	385	1199B	M12	13.250			21	Modelo americano Y2
1879 D CA	616190	7	810	400	195	1199B	M12	12.559				Cilíndrica Helicoidal N4
1879 I CA	616191	7	810	400	195	1199B	M12	12.559				Cilíndrica Helicoidal N4
1871 D CA	619068	7	193	260		1199B	M12	1.300		500		Cilíndrico Largo P4
1871 I CA	619069	7	193	260		1199B	M12	1.300		500		Cilíndrico Largo P4
1881 D CA	619200	7	196	286		1199B	M12	1.400		500		Cilíndrica Helicoidal N4
1881 I CA	619201	7	196	286		1199B	M12	1.400		500		Cilíndrica Helicoidal N4
1883 D CA	616074	7	882	438	187	1199B	M12	11.858				Cilíndrico Largo P4
1883 I CA	616075	7	882	438	187	1199B	M12	11.858				Cilíndrico Largo P4
2316 D	763008							2.100		300		Não reforçado
2316 I	763009							2.100		300		Não reforçado
2329	223122	10	452	110		1199D	M12	3.850		200		Reversível
2329 B	761108	10	550	110		1199D	M12	4.650		200		Reversível
2329 C	279140	10	550	130		1199D	M12	5.500		200		Reversível
2346 D	279138	10	155	76		1199D	M12	900		600		Clássico
2346 I	279139	10	155	76		1199D	M12	900		600		Clássico
2286-A	278074/75	10	420	110		1199B	M12	2.870		200		Tipo AV curto
2287-A	278076/77	10	653	110		1199B	M12	4.600		200		Tipo AR Largo

KUHN CLÁSSICO V

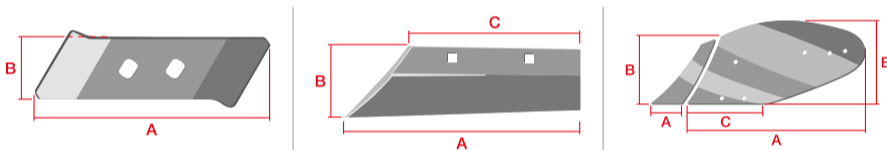

Ref.	Ref. Original	— —	A	B	C	⚙️	M	Grs.	🌀	F	Denom. part.
1385 D	622128 MARATHON	12	300	85		1199D	M12	1.850	300		
1385 I	622129 MARATHON	12	300	85		1199D	M12	1.850	300		
1385 D CP DURATOP	622164 SUPER MARATHON	22				1199D	M12	2.400	450		
1385 I CP DURATOP	622165 SUPER MARATHON	22				1199D	M12	2.400	450		
1383-14 D	622134	12	587	158	395	1199B	M14	5.500	100		Sem alerón
1383-14 I	622135	12	587	158	395	1199B	M14	5.500	100		Sem alerón
1383-16 D	622136	12	671	158	395	1199B	M14	6.200	100		Sem alerón
1383-16 I	622137	12	671	158	395	1199B	M14	6.200	100		Sem alerón
1393-14 D	580884	12	587	158	395	1199B	M14	5.500	80		Com alerón
1393-14 I	580885	12	587	158	395	1199B	M14	5.500	80		Com alerón
1393-16 D	580886	12	671	158	395	1199B	M14	6.200	80		
1393-16 I	580887	12	671	158	395	1199B	M14	6.200	80		
1733-1 D	H0404650 / 617100	10	868	60		1199B	M12	3.660			
1733-1 I	H0404660 / 617101	10	868	60		1199B	M12	3.660			
1733-2 D	H0404670 / 617102	10	955	60		1199B	M12	4.360			
1733-2 I	H0404680 / 617103	10	955	60		1199B	M12	4.360			
1733-3 D	H0404690 / 617104	10	762	60		1199B	M12	3.420			
1733-3 I	H0404700 / 617105	10	762	60		1199B	M12	3.420			
1733-4 D	H0404710 / 617106	10	569	102		1199B	M12	3.130			
1733-4 I	H0404720 / 617107	10	569	102		1199B	M12	3.130			
1734 D	619060	7	198	251		1199B	M12	1.360			
1734 I	619061	7	198	251		1199B	M12	1.360			
1735 D	616242	7	1030	470	238	1199B	M12	18.700		22	
1735 I	616243	7	1030	470	238	1199B	M12	18.700		22	
1736 D	619178	7	270	282		1199B	M12	2.100		50	
1736 I	619179	7	270	282		1199B	M12	2.100		50	
1738-1-D	H0403180	10	558	125		1199B	M12	3.850	200		
1738-1-I	H0403190	10	558	125		1199B	M12	3.850	200		
1738-2-D	H0403200	10	770	83		1199B	M12	4.100	100		
1738-2-I	H0403210	10	770	83		1199B	M12	4.100	100		
1738-3-D	H0403220	10	955	85		1199B	M12	4.600	100		
1738-3-I	H0403230	10	955	85		1199B	M12	4.600	100		
1738-4-D	H0403240	10	995	148		1199B	M12	6.400	100		
1738-4-I	H0403250	10	995	148		1199B	M12	6.400	100		
1739-D	H0403520	7	238	304		1199B	M12	2.250	250		
1739-I	H9403530	7	238	304		1199B	M12	2.250	250		
2329 B	761108	10	550	110		1199D	M12	4.650	200		Reversível
2329 C	279140	10	550	130		1199D	M12	5.500	200		Reversível
2375 D	761110	10	155	108		1199D	M12	825	1.000	50	Tipo L
2375 I	761111	10	155	108		1199D	M12	825	1.000	50	Tipo L
2383 D	761216	10	165	105		1199D	M12	900	1.000	50	Tipo SK
2383 I	761217	10	165	105		1199D	M12	900	1.000	50	Tipo SK

KUHN ZD, ZU, ZF

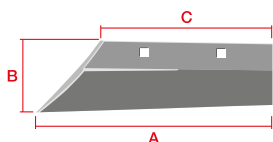

Ref.	Ref. Original	→ ←	A	B	C		M	Grs.			F	Denom. part.
1331 D CA1	631016	8	208	75	155	1199B	M10	1.000			100	
1331 I CA1	631017	8	208	75	155	1199B	M10	1.000			100	
1377 D	631018	7	175	77	175	1199B	M10	840				
1377 I	631019	7	175	77	175	1199B	M10	840				
1372 D	631030	8	285	81	190	1199B	M12	1.300				
1372 I	631031	8	285	81	190	1199B	M12	1.300				
1376 D	632002	9	142	72	98	1199B	M10	470			100	Tipo ZF
1376 I	632003	9	142	72	98	1199B	M10	470			100	Tipo ZF
1432 D	631104	10	336	105	210	1199B	M12	2.100				
1432 I	631105	10	336	105	210	1199B	M12	2.100				
1432 B	631112	10	350	105	172	1199B	M12	2.115			100	Reversível ZXL
1433 D	631100	10	270	107	180	1199B	M12	1.400				Tipo ZXE-ZRE
1433 I	631101	10	270	107	180	1199B	M12	1.400				
1737 D	619132	6	327	384	124	1199B	M12	3.990				
1737 I	619133	6	327	384	124	1199B	M12	3.990				
1809 D	618000	5	283	118		1199B	M10	850	12		50	
1809 I	618001	5	283	118		1199B	M10	850	12		50	

OVERUM V, UC

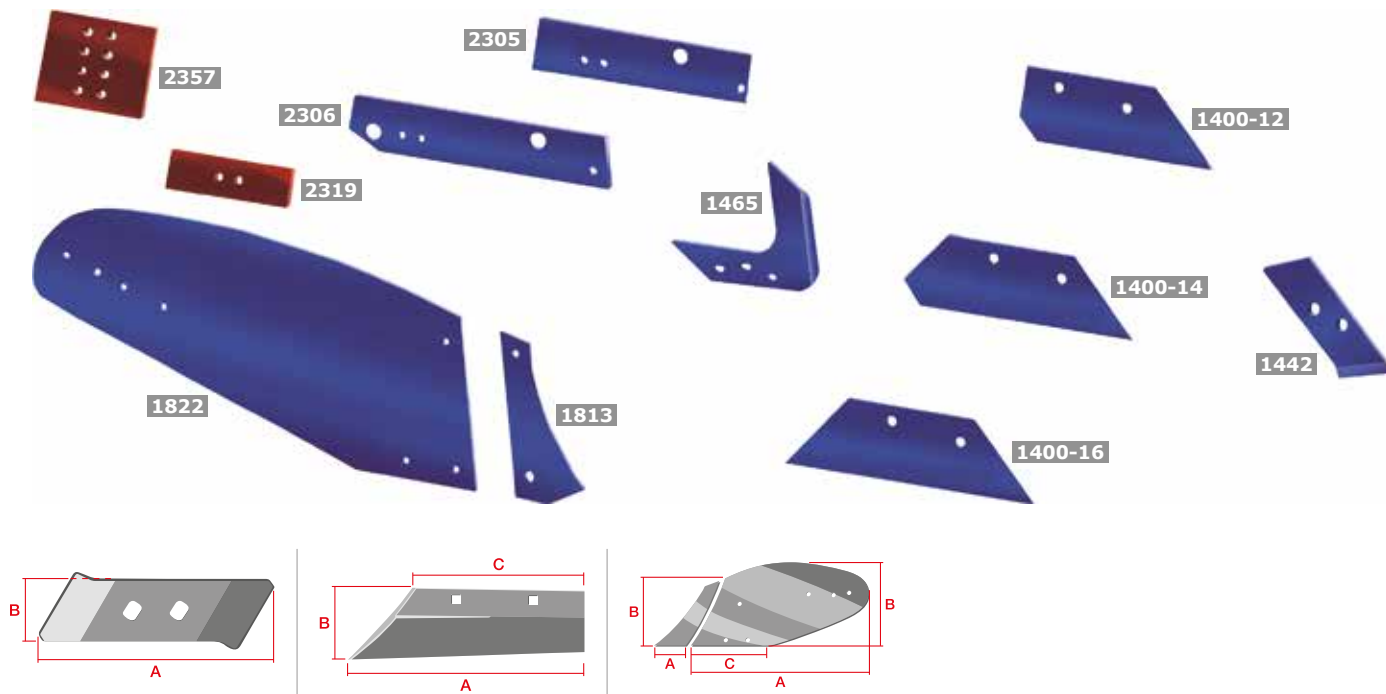

Ref.	Ref. Original	↔	A	B	C	⚙	M	Gr.	📦	🔧	F
1400-C 12 D	84069	9	405	150	255	1199B	M12	3.300		200	100
1400-C 12 I	84078	9	405	150	255	1199B	M12	3.300		200	100
1400-C 14 D	85383	9	480	150	255	1199B	M12	3.700		200	
1400-C 14 I	85381	9	480	150	255	1199B	M12	3.700		200	
1400-C 16 D	85384	9	510	150	255	1199B	M12	3.800		200	
1400-C 16 I	85382	9	510	150	255	1199B	M12	3.800		200	
1442 D	84060	12	315	100		1199B	M12	2.100		450	
1442 I	85143	12	315	100		1199B	M12	2.100		450	
1465 D	94622	6	197	65		1199B	M14	1.250		400	
1465 I	94623	6	197	65		1199B	M14	1.250		400	
1813-A D	83980	8	145	345		1199B	M12	1.780	12	540	
1813-A I	84083	8	145	345		1199B	M12	1.780	12	540	
1822 D	85261	7	950	390		1199B	M12	14.600			
1822 I	85262	7	950	390		1199B	M12	14.600			
2305-A D	83981	12	425	100		1199B	M20	3.925		200	50
2305-A I	85196	12	425	100		1199B	M20	3.925		200	50
2306 D	85118	12	520	100		1199B	M12	4.700		200	50
2306 I	85197	12	520	100		1199B	M12	4.700		200	50
2319	063600A	12	240	70		1199D	M12	1.400		500	
2357	063601A	12	214	180		1199D	M12	3.150		300	

OVERUM XL

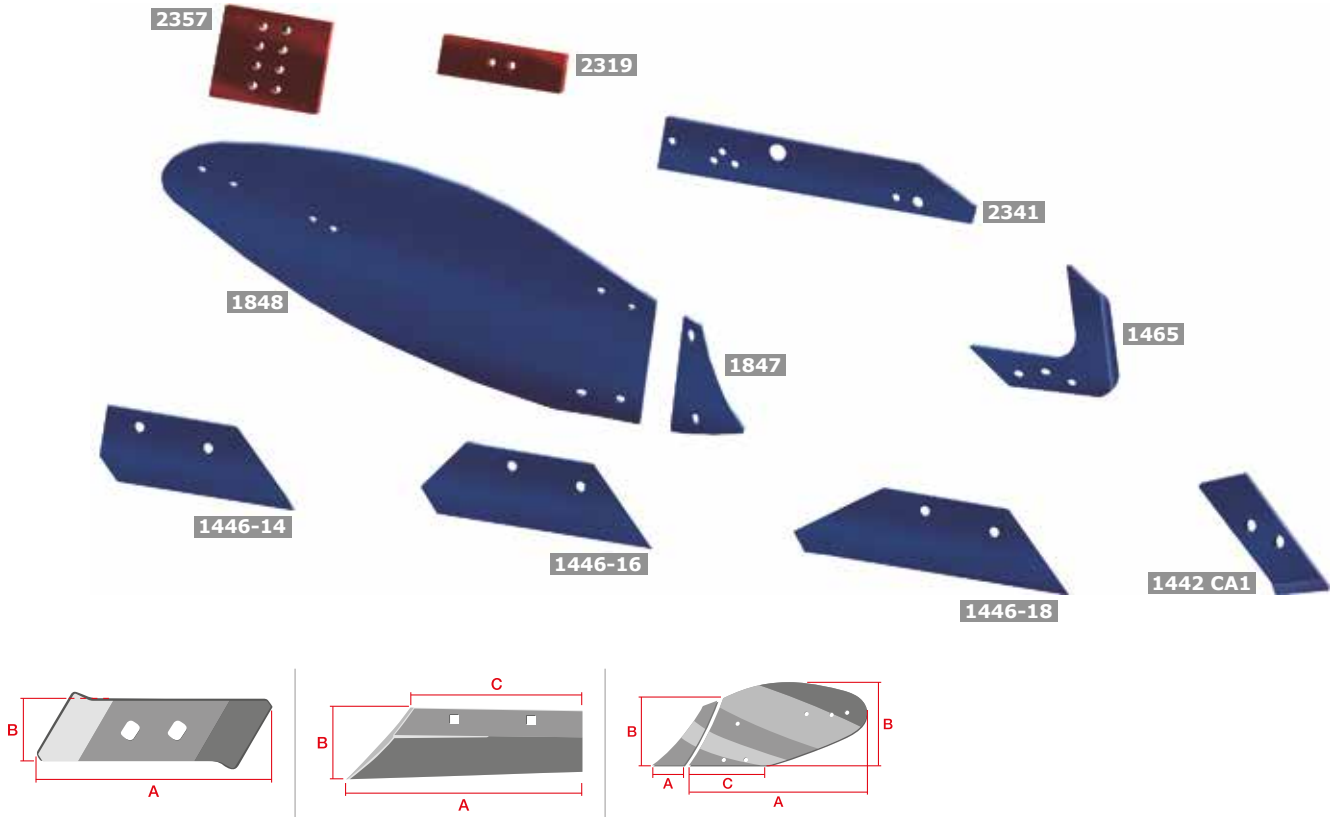

Ref.	Ref. Original	\pm	A	B	C		M	Grs.		F
1442 D CA1	94608	12	315	100		1199B	M12	2.100	450	
1442 I CA1	94609	12	315	100		1199B	M12	2.100	450	
1446-14 D	94598	10,5	392	150	246	1199B	M12	2.950	250	100
1446-14 I	94599	10,5	392	150	246	1199B	M12	2.950	250	100
1446-16 D	94600	10,5	467	150	246	1199B	M12	3.425	200	
1446-16 I	94601	10,5	467	150	246	1199B	M12	3.425	200	
1446-18 D	94602	10,5	542	150	246	1199B	M12	3.800	200	
1446-18 I	94603	10,5	542	150	246	1199B	M12	3.800	200	
1465 D	94622	6	197	65		1199B	M14	1.250	400	
1465 I	94623	6	197	65		1199B	M14	1.250	400	
1847 D	94596	7	161	258		1199B	M12	1.190	300	
1847 I	94597	7	161	258		1199B	M12	1.190	300	
1848 D	94594	7	1022	421		1199B	M12	16.200		
1848 I	94595	7	1022	421		1199B	M12	16.200		
2319	063600A	12	240	70		1199D	M12	1.400	500	
2341 D	94604	12	620	100		1199B	M12	5.230	150	
2341 I	94605	12	620	100		1199B	M12	5.230	150	
2357	063601A	12	214	180		1199D	M12	3.150	300	

OVERUM SR

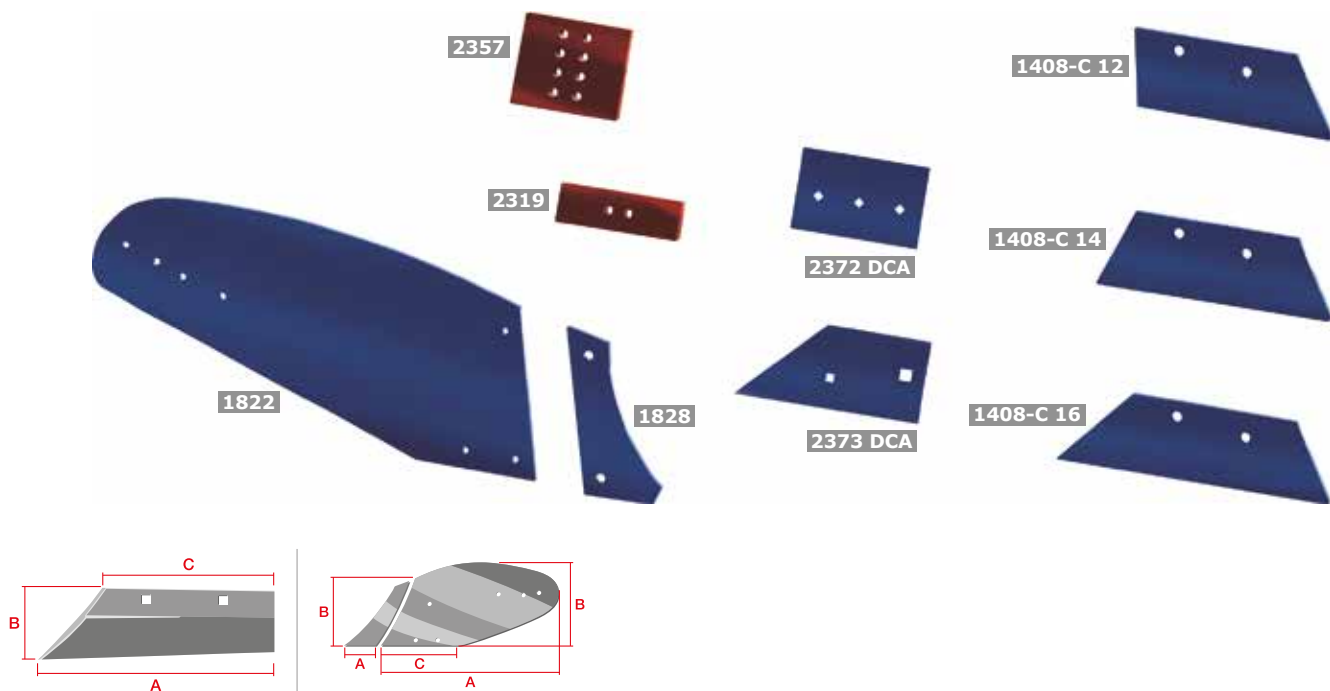

Ref.	Ref. Original		A	B	C		M	Grs.			F
1408-C 14 D	74606	10	470	150	330	1199A	7/16"	4.400		200	
1408-C 16 D	74607	10	545	150	330	1199A	7/16"	4.750		200	
1822 D	85261	7	950	390		1199B	M12	14.600			
1828 D	80609	8	135	320		1199B	M12	1.825	12	540	
2319	063600A	12	240	70		1199D	M12	1.400		500	
2357	063601A	12	214	180		1199D	M12	3.150		300	
2372 DCA	74612	12	187	120		1199A	7/16"	2.100		500	50
2373 DCA	74602	12	275	120		1199A	7/16" / 3/4"	2.350		450	50

1

PLANTIO

2

DESCOMPACTADOR
DENTES CORVOS

3

CULTIVADOR

4

GRADE

5

CHARRUA

FISKARS-AGROLUX FK

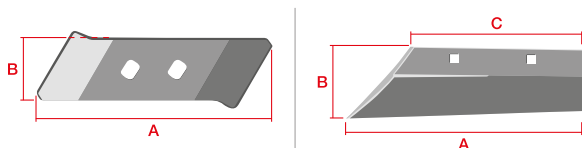
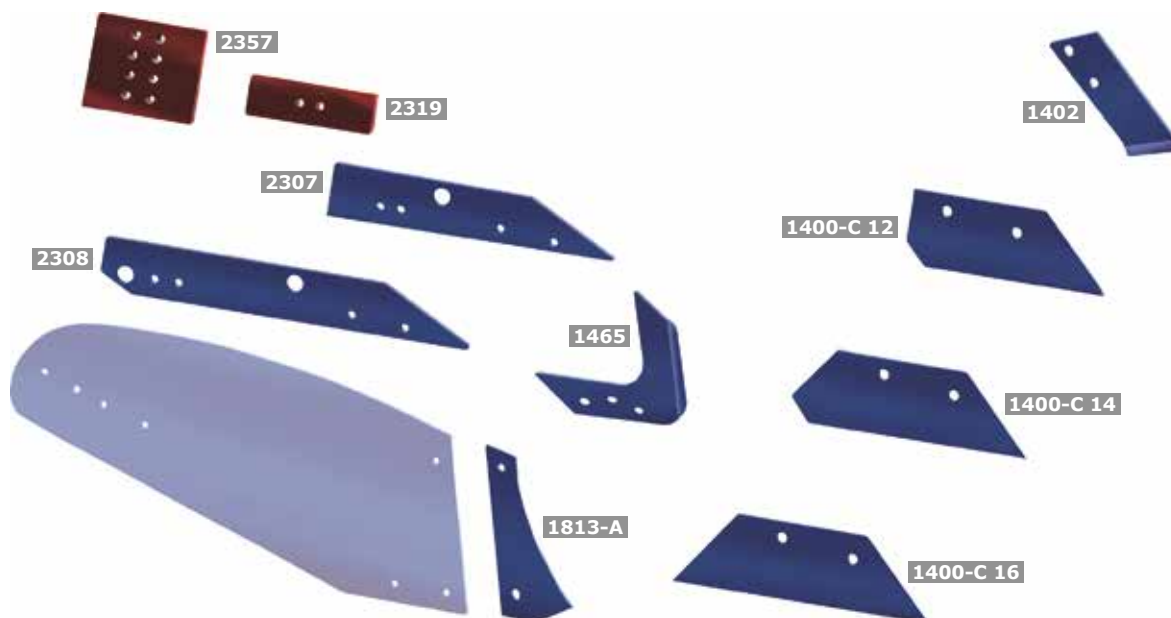

Ref.	Ref. Original	\rightarrow \leftarrow	A	B	C		M	Grs.		F
1400-C 12 D	84069	10,5	405	150	255	1199B	M12	3.300	200	100
1400-C 12 I	84078	10,5	405	150	255	1199B	M12	3.300	200	100
1400-C 14 D	85383	10,5	480	150	255	1199B	M12	3.700	200	
1400-C 14 I	85381	10,5	480	150	255	1199B	M12	3.700	200	
1400-C 16 D	85384	10,5	510	150	255	1199B	M12	3.800	200	
1400-C 16 I	85382	10,5	510	150	255	1199B	M12	3.800	200	
1402 D	84942	12	325	85		1199B	M12	2.000	350	
1402 I	85204	12	325	85		1199B	M12	2.000	350	
1465 D	94622	6	197	65		1199B	M14	1.250	500	
1465 I	94623	6	197	65		1199B	M14	1.250	500	
1813-A D	83980	8	145	345		1199B	M12	1.780	540	
1813-A I	84083	8	145	345		1199B	M12	1.780	540	
2307 D	85675	12	570	100		1199B	M12	4.500	200	50
2307 I	86126	12	570	100		1199B	M12	4.500	200	50
2308 D	85799	12	732	100		1199B	M12	6.000	150	50
2308 I	86136	12	732	100		1199B	M12	6.000	150	50
2319	063600A	12	240	70		1199D	M12	1.400	500	
2357	063601A	12	214	180		1199D	M16	3.150	300	

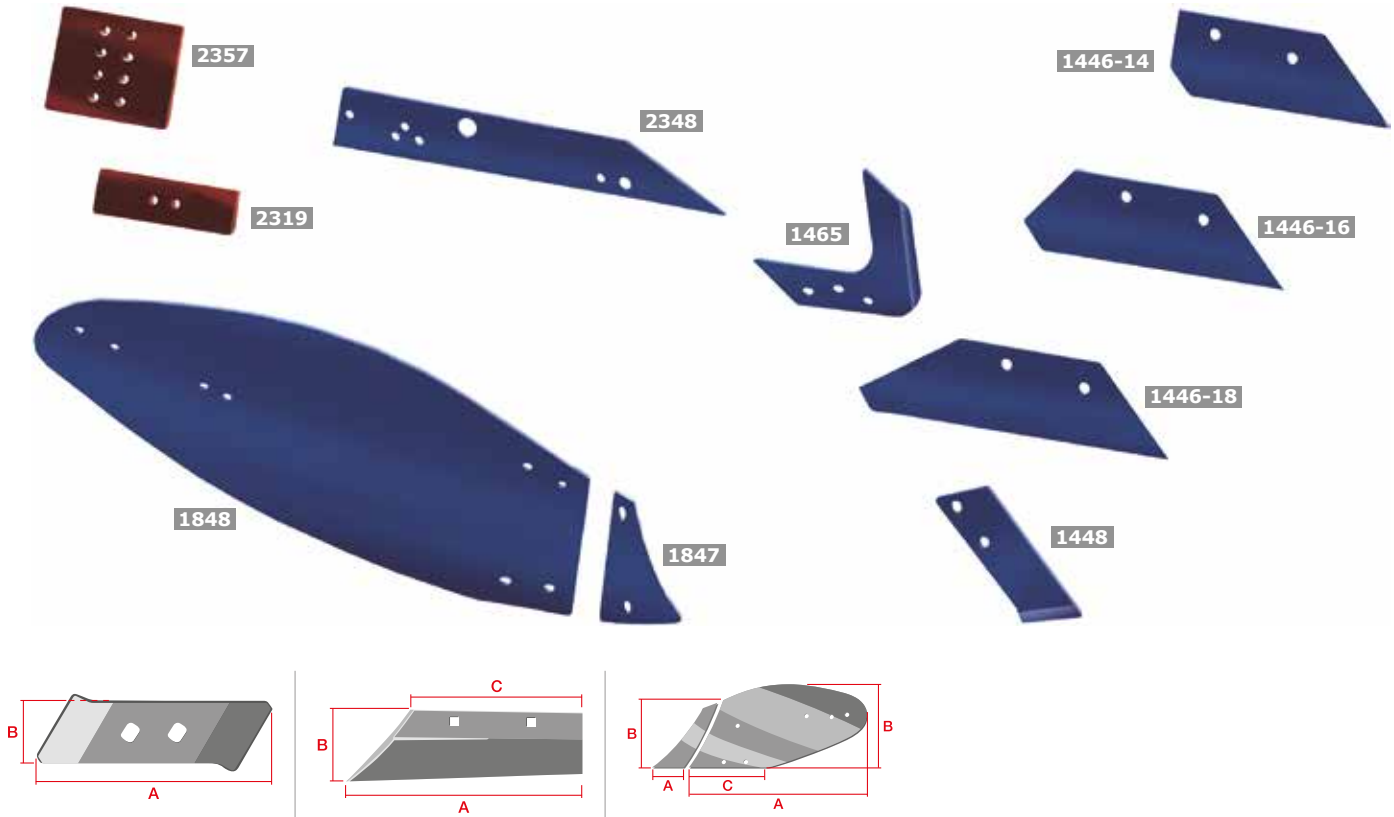

FISKARS-AGROLUX AX

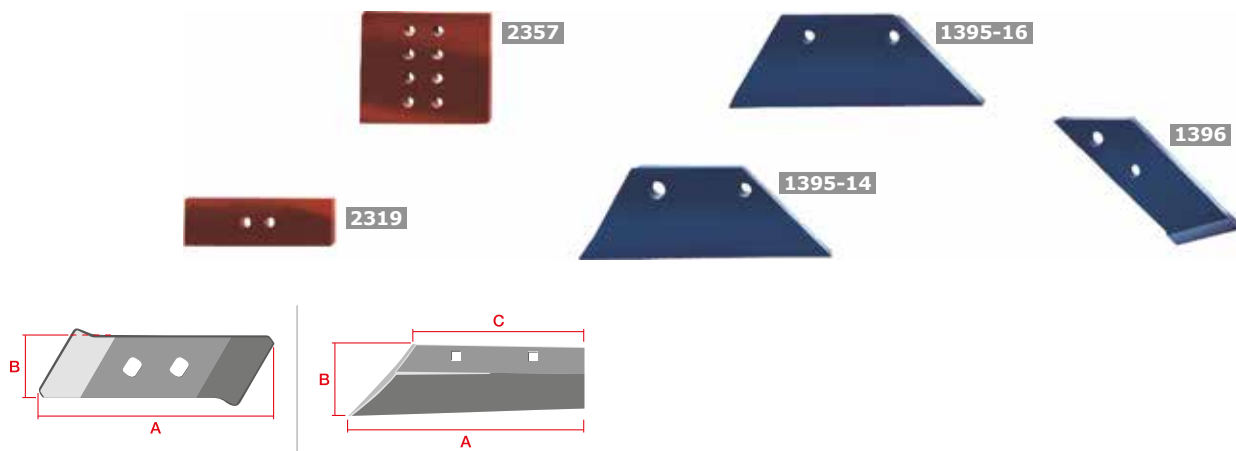

Ref.	Ref. Original	\pm	A	B	C		M	Grs.		F
1446-14 D	94598	10,5	392	150	246	1199B	M12	2.950	250	100
1446-14 I	94599	10,5	392	150	246	1199B	M12	2.950	250	100
1446-16 D	94600	10,5	467	150	246	1199B	M12	3.425	200	
1446-16 I	94601	10,5	467	150	246	1199B	M12	3.425	200	
1446-18 D	94602	10,5	542	150	246	1199B	M12	3.800	200	
1446-18 I	94603	10,5	542	150	246	1199B	M12	3.800	200	
1448 D	94610	12	275	85		1199B	M12	2.000	350	
1448 I	94611	12	275	85		1199B	M12	2.000	350	
1465 D	94622	6	197	65		1199B	M14	1.250	500	
1465 I	94623	6	197	65		1199B	M14	1.250	500	
1847 D	94596	7	161	258		1199B	M12	1.190	300	
1847 I	94597	7	161	258		1199B	M12	1.190	300	
1848 D	94594	7	1022	421		1199B	M12	16.200	1.000	
1848 I	94595	7	1022	421		1199B	M12	16.200	1.000	
2319	063600A	12	240	70		1199D	M12	1.400	500	
2348 D	94606	12	610	100		1199B	M12	4.950	150	
2348 I	94607	12	610	100		1199B	M12	4.950	150	
2357	063601A	12	214	180		1199D	M16	3.150	300	

FISKARS-AGROLUX KH



Ref.	Ref. Original	— —	A	B	C		M	Grs.	
1395-14 D	95000683	8	398	155	180	1199B	M12	2.700	200
1395-16 D	95000684	8	425	155	180	1199B	M12	2.850	200
1396 D	95000675	12	300	100		1199B	M12	2.450	250
2319	063600A	12	240	70		1199D	M12	1.400	500
2357	063601A	12	214	180		1199D	M16	3.150	300

1

PLANTIO

2

DESCOMPACTADOR
DENTES CORVOS

3

CULTIVADOR

4

GRADE

5

CHARRUA

FISKARS-AGROLUX KHN

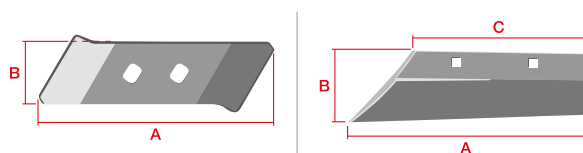
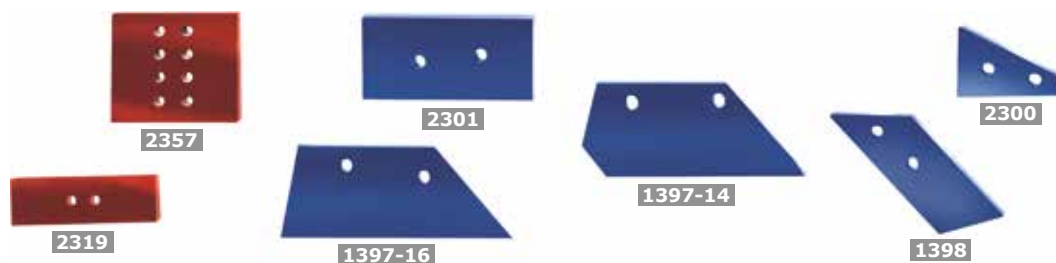

Ref.	Ref. Original	$\rightarrow \leftarrow$	A	B	C		M	Grs.		F
1397-14 D	95002561	8	383	155	220	1199B	M12	2.730	200	
1397-16 D	95002489	8	393	155	220	1199B	M12	2.800	200	
1397-16 I	95004120	8	393	155	220	1199B	M12	2.800	200	100
1398 D	95002490	12	340	100		1199B	M12	2.300	250	
1398 I	95004118	12	340	100		1199B	M12	2.300	250	100
2300 D	95003732	10	180	120		1199B	M12	1.000	600	50
2300 I	95004242	10	180	120		1199B	M12	1.000	600	50
2319	063600A	12	240	70		1199D	M12	1.400	500	
2357	063601A	12	214	180		1199D	M16	3.150	300	

1

PLANTIO

2

DESCOMPACTADOR
DENTES CORVOS

3

CULTIVADOR

4

GRADE

5

CHARRUA

FISKARS-AGROLUX



1983 R81 F9



1983 R70 D4



1990 R81 F9



1990 R70 D4



1407

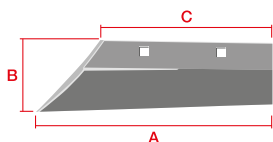

Ref.	Ref. Original	— —	A	B	C		M	Grs.		F
1407 D	91801	8	245	110	245	1199B	M12	1.360	500	
1407 I	91802	8	245	110	245	1199B	M12	1.360	500	
1983-18 5 R.81 F9	72547	5	457					6.400	50	16
1983-20 5 R.81 F9	80662	5	508					7.900	50	16
1990-20 4 R.81 F9	80663	4	508					6.300	50	16
1983-18 5 R.70 D4	95000837	5	457					6.400	50	16
1983-20 5 R.70 D4	95000474	5	508					7.900	50	16
1990-20 4 R.70 D4	95002753	4	508					6.300	50	16

1

PLANTIO

2

DESCOMPACTADOR
DENTES CORVOS

3

CULTIVADOR

4

GRADE

5

CHARRUA

VOGEL & NOOT WS

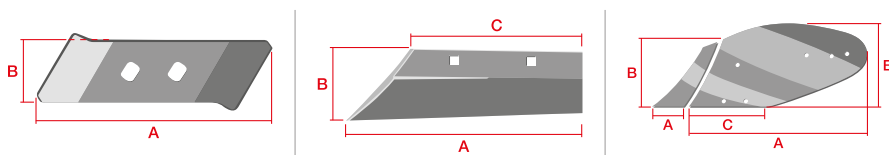
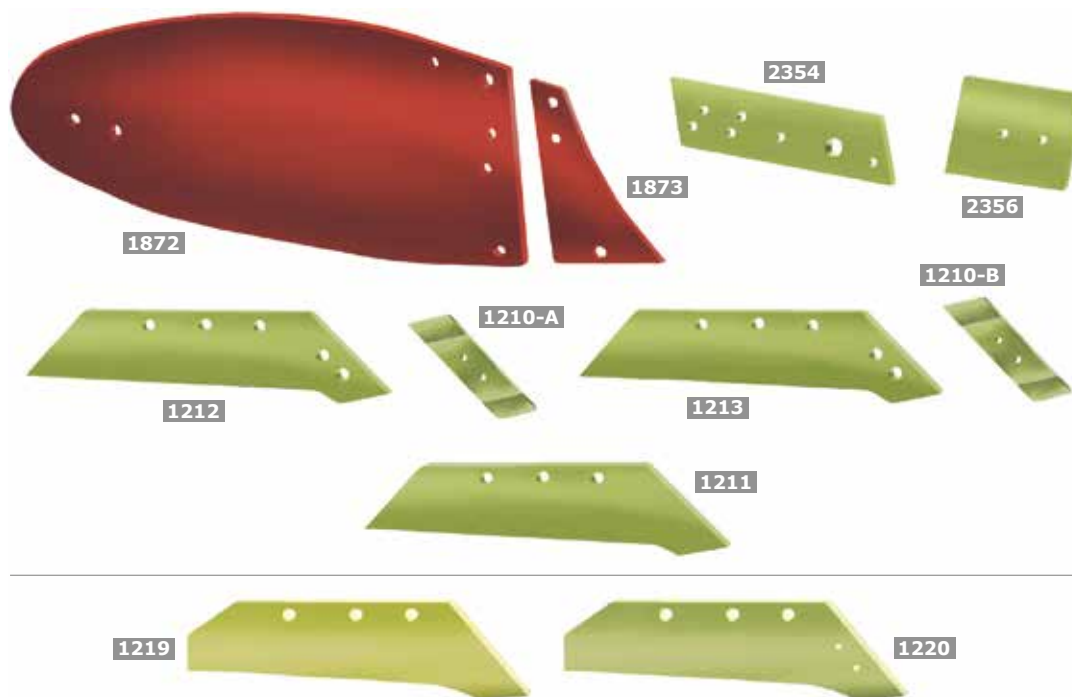

Ref.	Ref. Original		A	B	C		M	Grs.		F
1210-A D	PK8.011.01-PK 8	14	290	65		1199D	M12	1.500	400	
1210-A I	PK8.011.02-PK8 L	14	290	65		1199D	M12	1.500	400	
1210-B D	PK0.011.01-PK0	14	290	65		1199D	M12	1.500	400	100
1210-B I	PK0.011.02-PK0 L	14	290	65		1199D	M12	1.500	400	100
1211-40 D	PK0.000.05-WS400	13	612	116	385	1199D	M14	5.500	125	
1211-40 I	PK0.000.06-WS400 L	13	612	116	385	1199D	M14	5.500	125	
1211-43 D	PK0.000.07-WS430	13	658	114	410	1199D	M14	5.800	125	100
1211-43 I	PK0.000.08-WS430 L	13	658	114	410	1199D	M14	5.800	125	100
1212-35 D	PK6.013.01-WSM35	13	553	119	375	1199D	M14	5.200	150	100
1212-35 I	PK6.014.01-WSM35 L	13	553	119	375	1199D	M14	5.200	150	100
1212-40 D	PK7.013.01-WSM40	13	612	116	385	1199D	M14	5.500	125	
1212-40 I	PK7.014.01-WSM40 L	13	612	116	385	1199D	M14	5.500	125	
1212-43 D	PK8.013.01-WSM430	13	658	114	410	1199D	M14	5.800	125	
1212-43 I	PK8.014.01WSM430 L	13	658	114	410	1199D	M14	5.800	125	
1213-40 D	PK0.010.05-WS400M	13	612	116	385	1199D	M14	5.360	125	100
1213-40 I	PK0.010.06-WS400M L	13	612	116	385	1199D	M14	5.360	125	100
1872 D	PK8.001.01-WY400	8	905	415	190		M10 / M12	19.700	50	
1872 I	PK8.002.01-WY400 L	8	905	415	190		M10 / M12	19.700	50	
1873 D	PK8.005.01-WY400A	8	206	335		1199B	M10	2.300	300	
1873 I	PK8.006.01-WY400A L	8	206	335		1199B	M10	2.300	300	
2354 D	PK8.034.01	12	385	120		1199D	M12	4.350	200	
2354 I	PK8.035.01	12	385	120		1199D	M12	4.350	200	
2356	P58.011.01	12	214	180		1199D	M12	3.150	300	
1219-40 D	P91.030.01-V1500	13	612	120	390	1199B	M14	6.200	125	
1219-40 I	P91.031.01-V1500 L	13	612	120	390	1199B	M14	6.200	125	
1220-40 D	P91.034.03-U1500M	13	612	120	390	1199B	M14	6.200	100	
1220-40 I	P91.035.03-U1500M L	13	612	120	390	1199B	M14	6.200	100	

VOGEL & NOOT UN

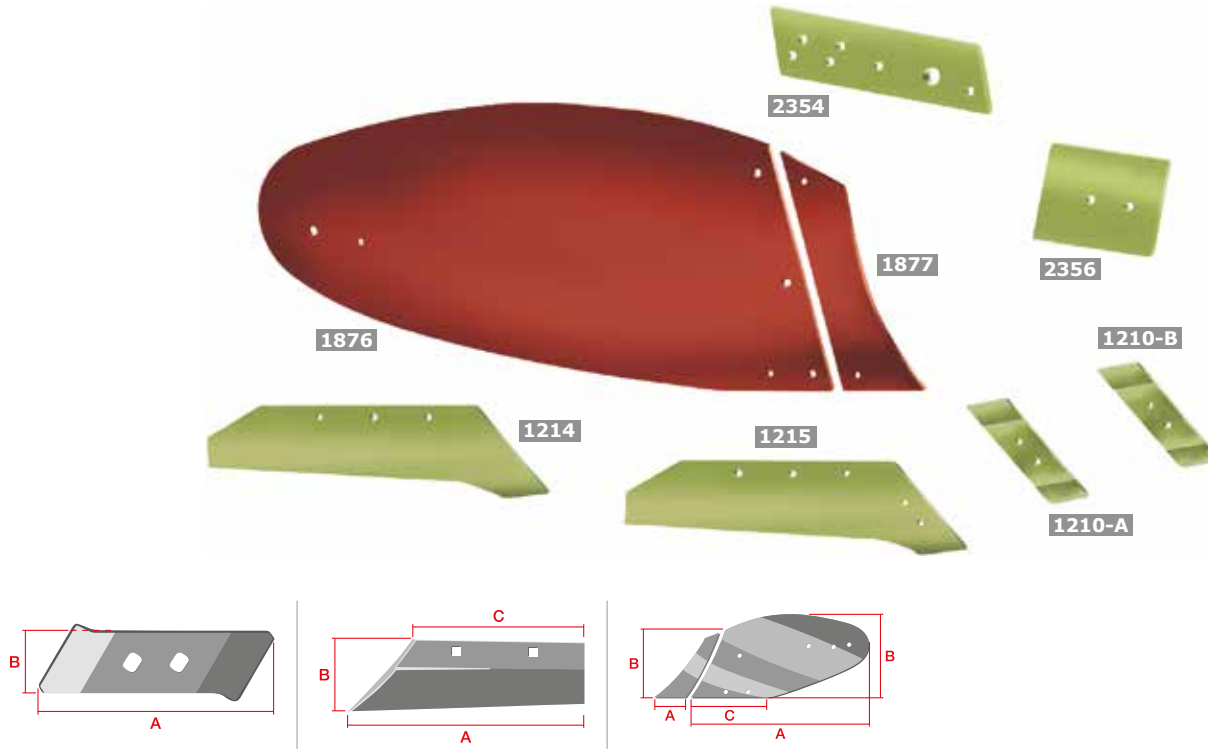

Ref.	Ref. Original		A	B	C		M	Grs.		F
1210-A D	PK8.011.01-PK 8	14	290	65		1199D	M12	1.500	400	
1210-A I	PK8.011.02-PK8 L	14	290	65		1199D	M12	1.500	400	
1210-B D	PK0.011.01-PK0	14	290	65		1199D	M12	1.500	400	100
1210-B I	PK0.011.02-PK0 L	14	290	65		1199D	M12	1.500	400	100
1214-35 D	PK3.001.01-UN350	13	545	124	330	1199D	M14	5.500	150	100
1214-35 I	PK3.002.01-UN350 L	13	545	124	330	1199D	M14	5.500	150	100
1214-40 D	PK4.001.01-UN400	13	612	120	390	1199D	M14	6.200	125	100
1214-40 I	PK4.002.01-UN400 L	13	612	120	390	1199D	M14	6.200	125	100
1215-35 D	PK3.013.01-UNM35	13	545	124	330	1199D	M14	5.500	150	
1215-35 I	PK3.014.01-UNM35 L	13	545	124	330	1199D	M14	5.500	150	
1215-40 D	PK4.013.01-UNM40	13	612	120	390	1199D	M14	6.200	125	
1215-40 I	PK4.014.01-UNM40 L	13	612	120	390	1199D	M14	6.200	125	
1215-43 D	PK5.013.01-UNM43	13	656	117	415	1199D	M14	6.760	125	
1215-43 I	PK5.014.01-UNM43 L	13	656	117	415	1199D	M14	6.760	125	
1876 D	PK4.001.02-UN400	8	730	405	250		M12	13.300		
1876 I	PK4.002.02-UN400 L	8	730	405	250		M12	13.300		
1877 D	PK4.001.03-UN400	8	127	360		1199B	M12	1.500	400	
1877 I	PK4.002.03-UN400 L	8	127	360		1199B	M12	1.500	400	
2354 D	PK8.034.01	12	385	120		1199D	M12	4.350	200	
2354 I	PK8.035.01	12	385	120		1199D	M12	4.350	200	
2356	P58.011.01	12	214	180		1199D	M12	3.150	300	

NAUD

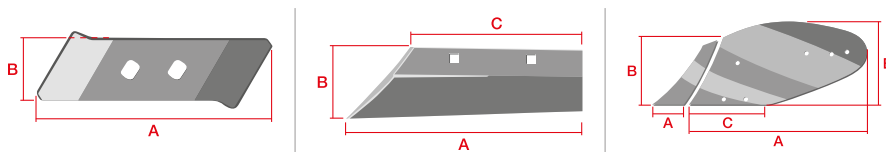
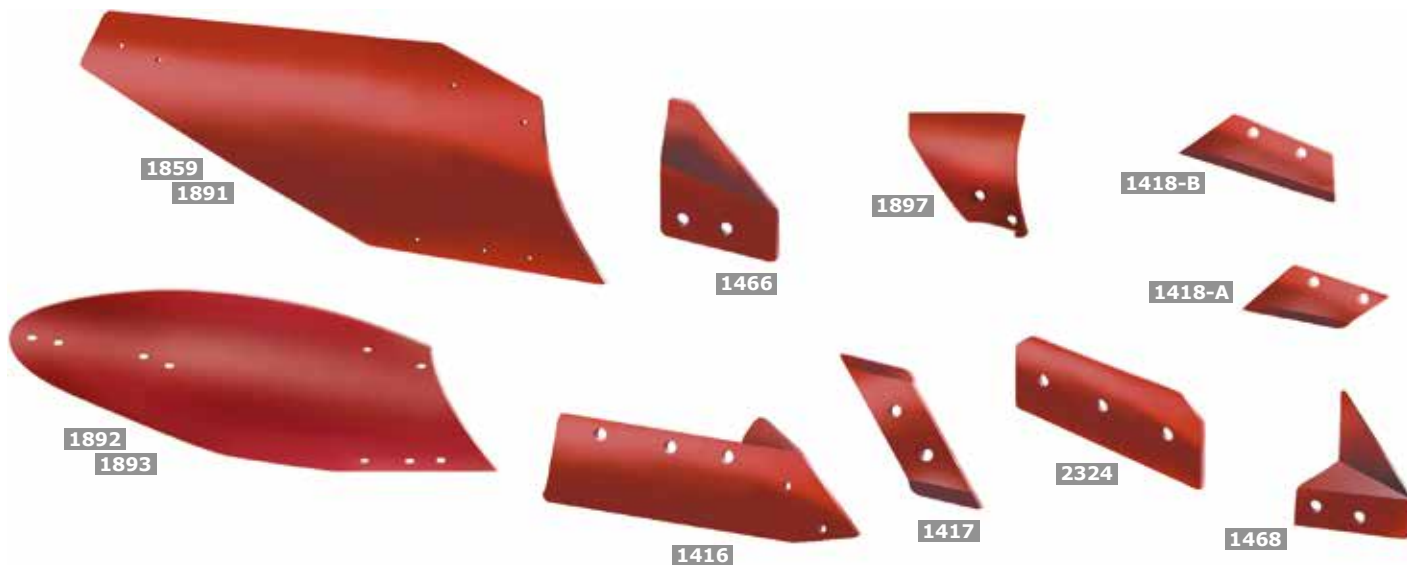

Ref.	Ref. Original		A	B	C		M	Grs.		F
1416 D	03054452D	10	540	150	418	1199B	M14	6.300	70	
1416 I	03054452G	10	540	150	418	1199B	M14	6.300	70	
1417 D	03054502D	12	355	90		1199B	M14	2.150	300	
1417 I	03054502G	12	355	90		1199B	M14	2.150	300	
1418-A D	04032101D	8	230	80	175	1199B	M10	950	600	
1418-A I	04032101G	8	230	80	175	1199B	M10	950	600	
1418-B D	04032104D	8	326	66	210	1199B	M10	1.300	600	100
1418-B I	04032104G	8	326	66	210	1199B	M10	1.300	600	100
1468 D	03060116D	6	200	275		1199B	M14	1.500	400	100
1468 I	03060116G	6	200	275		1199B	M14	1.500	400	100
1859 D	C31 A 03022352D	8	950	365	420	1199B	M12	14.450		24
1859 I	C31 A 03022352G	8	950	365	420	1199B	M12	14.450		24
1891 D	C34 A 03022354D	8	1038	396	420	1199B	M12	17.150		21
1891 I	C34 A 03022354G	8	1038	396	420	1199B	M12	17.150		21
1892 D	H55 A 03023555D	8	950	389	420	1199B	M12	17.150		21
1892 I	H55 A 03023555G	8	950	389	420	1199B	M12	17.150		21
1893 D	H67 A 03023657D	8	1225	405	420	1199B	M12	22.650		15
1893 I	H67 A 03023657G	8	1225	405	420	1199B	M12	22.650		15
1897 D	400421D	6	300	238		1199B	M10	2.790	200	
1897 I	400421G	6	300	238		1199B	M10	2.790	200	
2324	03065501	10	330	150		1199B	M14	3.700	250	

DOWDESWELL

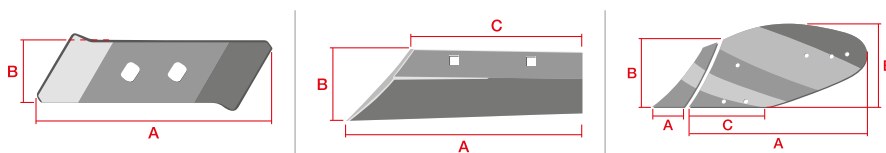
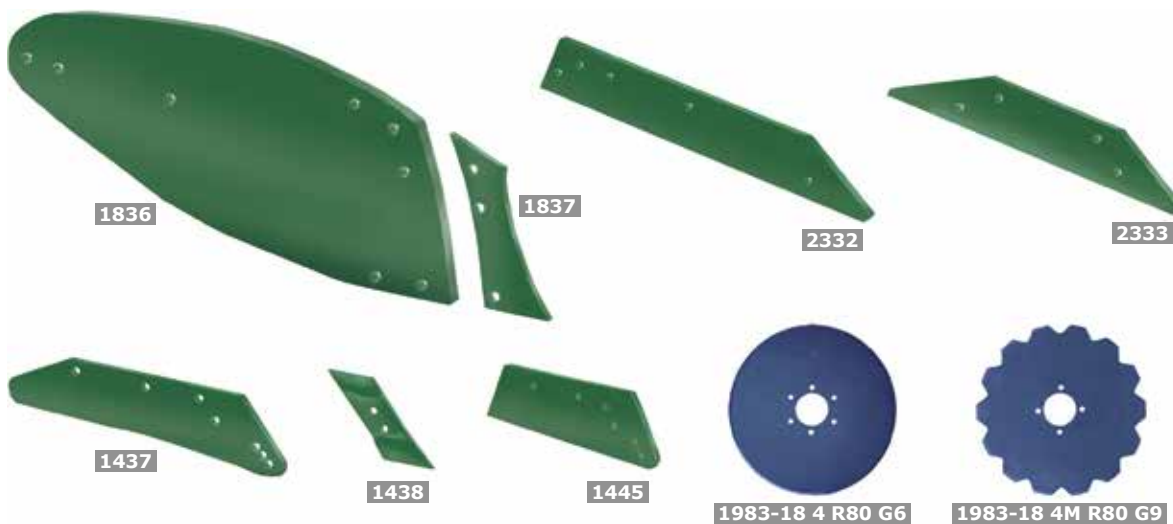

Ref.	Ref. Original		A	B	C		M	Grs.		F
1437 D	1138398	10	624	120	380		M12	5.300	125	
1437 I	1138399	10	624	120	380		M12	5.300	125	
1438 D	901953	13	305	67			M12	1.500	500	100
1438 I	901954	13	305	67			M12	1.500	500	100
1445 D CA1	115398	8,5	390	113,5	282		M12	2.870	200	
1445 I CA1	115399	8,5	390	113,5	282		M12	2.870	200	
1836 D	1136598	8	1050	435	282	1199B	M12	20.500	1.000	18
1836 I	1136599	8	1050	435	282	1199B	M12	20.500	1.000	18
1837 D	1136698	7	156	357		1199B	M12	2.000	300	50
1837 I	1136699	7	156	357		1199B	M12	2.000	300	50
1983-18 4 R80 G6	052800	4	457					4.680		16
1983-18 4M R80 G9	063800	4	457					4.110		16
2332 D	1137498	12	760	120			M12	7.700	100	50
2332 I	1137499	12	760	120			M12	7.700	100	50
2333	1136700	12	670	120			M12	5.800	150	50

INTERNATIONAL HARVESTER

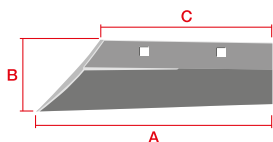

Ref.	Ref. Original		A	B	C		M	Grs.		F
1331 D CA1	735558	8	208	75	158	1199B	M10	1.000	600	100
1331 I CA1	735557	8	208	75	158	1199B	M10	1.000	600	100
1378-14 D	1867675	12	584	131	465	1199E	1/2 Esq.	5.200	150	
1378-14 I	1867674	12	584	131	465	1199E	1/2 Esq.	5.200	150	
1379 D	1867673	12	268	70		1199E	1/2 Esq.	1.130	500	100
1379 I	1867672	12	268	70		1199E	1/2 Esq.	1.130	500	100
1380-14 D	737339	12	515	110	395	1199E	1/2 Esq.	3.800	200	100
1380-14 I	737338	12	515	110	395	1199E	1/2 Esq.	3.800	200	100
1381-14 D	3171927	12	584	131	465	1199E	1/2 Esq.	5.200	150	100
1381-14 I	3171926	12	584	131	465	1199E	1/2 Esq.	5.200	150	100
1382-14 D	1867679	12	515	110	395	1199E	1/2 Esq.	3.800	200	100
1382-14 I	1867678	12	515	110	395	1199E	1/2 Esq.	3.800	200	100
1404-14 D	737339	12	533	130	395	1199E	1/2 Esq.	5.100	150	
1404-14 I	737338	12	533	130	395	1199E	1/2 Esq.	5.100	150	
1405-14 D	1867679	12	533	130	395	1199E	1/2 Esq.	5.100	150	
1405-14 I	1867678	12	533	130	395	1199E	1/2 Esq.	5.100	150	

1

PLANTIO

2

DESCOMPACTADOR
DENTES CORVOS

3

CULTIVADOR

4

GRADE

5

CHARRUA

OVLAC MINI

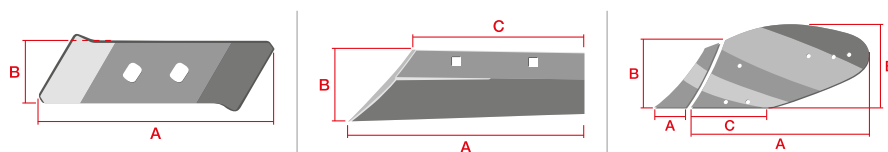

Ref.	Ref. Original		Grs.			A	B	C		M	F
1741 D	64000306	6	8.440		90	705	341	333	1199B	M10	50
1741 I	64000307	6	8.440		90	705	341	333	1199B	M10	50
1329 11 C D	64000195	11	3.000		350	411	97	327	1199D	M12	
1329 11 C I	64000215	11	3.000		350	411	97	327	1199D	M12	
2368 D	64000196	12	2.800		350	337	100	274	1199D	M12	
2368 I	64000216	12	2.800		350	337	100	274	1199D	M12	
1330 D	64000194	12	1.300		500	260	65		1199D	M12	
1330 I	64000213	12	1.300		500	260	65		1199D	M12	

1

PLANTIO

2

DESCOMPACTADOR
DENTES CORVOS

3

CULTIVADOR

4

GRADE

5

CHARRUA

OVLAC SS-SL

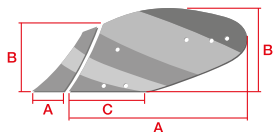
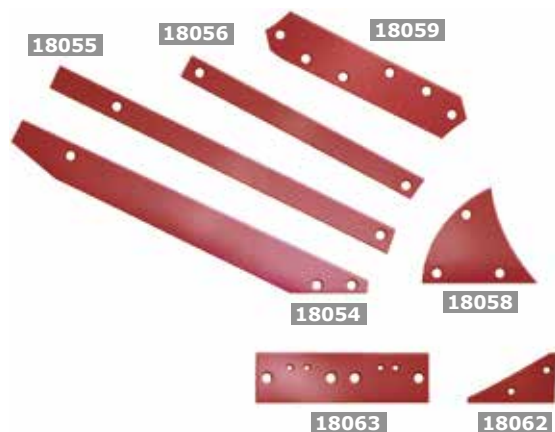

Ref. Original	Ref.	→ ←	Grs.		A	B		M
64000457	18054 D R CA1	10	7.250	100	990	112	1199A	M12
64000458	18054 I R CA1	10	7.250	100	990	112	1199A	M12
64000455	18055 D R CA1	10	4.450	250	958	60	1199A	M12
64000456	18055 I R CA1	10	4.450	250	958	60	1199A	M12
64000453	18056 D R CA1	10	3.100	300	676	60	1199A	M12
64000454	18056 I R CA1	10	3.100	300	676	60	1199A	M12
64000585	18059 D R CA1	10	4.750	200	510	118	1199A	M12
64000586	18059 I R CA1	10	4.750	200	510	118	1199A	M12
64000128	18058 D R	10	3.000	300	290	242	1199A	M10
64000129	18058 I R	10	3.000	300	290	242	1199A	M10
64000137	18062 D R	10	1.000	1.000	206	120	1199A	M10
64000138	18062 I R	10	1.000	1.000	206	120	1199A	M10
64000136	18063 R	12	4.500	200	420	120	1199A	M12

OVLAC

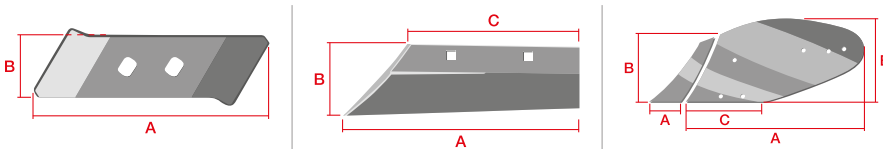
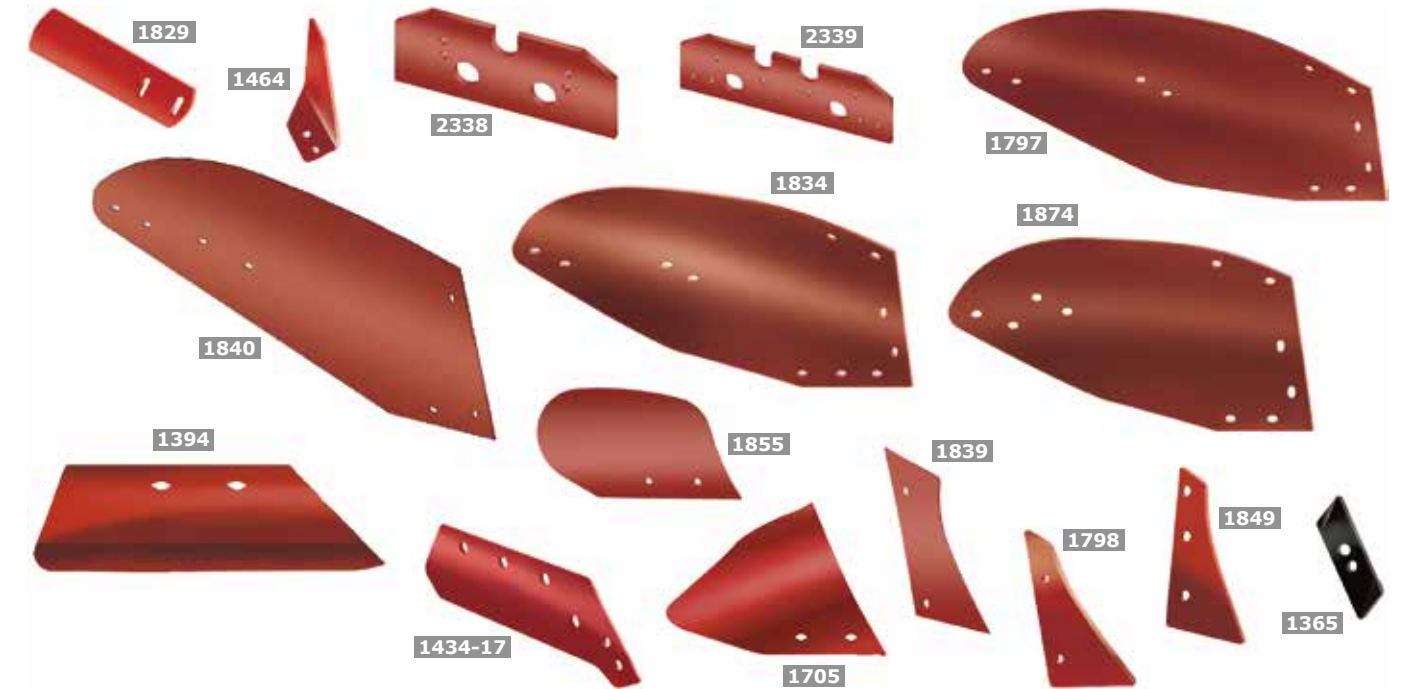

Ref.	Ref. Original	↔	A	B	C	⚙	M	Grs.	📦	📦	F
1365 D CA CG	64000033	12	258,5	65		1199D	M12	1.300		500	
1365 I CA CG	64000034	12	258,5	65		1199D	M12	1.300		500	
1394 D	64000054	8	330	100	210	1199B	M10	1.550		350	
1394 I	64000056	8	330	100	210	1199B	M10	1.550		350	
1434-17 D	64000051	11	635	145	465	1199C	M14	6.240	6	144	
1434-17 I	64000052	11	635	145	465	1199C	M14	6.240	6	144	
1464 D	64000063	4,5	283	145		1199D		830		500	
1464 I	64000064	4,5	283	145		1199D		830		500	
1705 D CA	64000190	5	369	165	214	1199B	M10	3.000		150	
1705 I CA	64000191	5	369	165	214	1199B	M10	3.000		150	
1797 D CA1	64000065	8	1059	477	222	1199B	M12	20.900			
1797 I CA1	64000066	8	1059	477	222	1199B	M12	20.900			
1798 D CA1	64000014	7	162	278		1199B	M12	1.310	12	648	50
1798 I CA1	64000067	7	162	278		1199B	M12	1.310	12	648	50
1829 D CA	64000069	8	365	100		1199B	M12	1.900	12	432	
1829 I CA	64000070	8	365	100		1199B	M12	1.900	12	432	
1834 D BO	64000073	8	980	440	280	1199B	M12	20.700			
1834 I BO	64000074	8	980	440	280	1199B	M12	20.700			
1839 D BO	64000038	8	182	340	236	1199B	M12	2.570		250	
1839 I BO	64000039	8	182	340	236	1199B	M12	2.570		250	
1840 D BO	64000032	8	1000	450		1199B	M12	17.450			
1840 I BO	64000037	8	1000	450		1199B	M12	17.450			
1849 D BO	64000087	8	160	325		1199B	M12	1.800		400	
1849 I BO	64000088	8	160	325		1199B	M12	1.800		400	
1849-12 D		12	160	325		1199B	M12	2.810		330	50
1849-12 I		12	160	325		1199B	M12	2.810		330	50
1855 D BO	61004900	6	329	165		1199B	M10	1.725		250	
1855 I BO	61005900	6	329	165		1199B	M10	1.725		250	
1874 D BO	64000096	8	780	395	200	1199B	M12	14.150			
1874 I BO	64000097	8	780	395	200	1199B	M12	14.150			
2338	64000044	12	356	140		1199D	M12	4.100		150	
2339	64000045	12	456	140		1199D	M12	5.150		150	

ESCUDERO

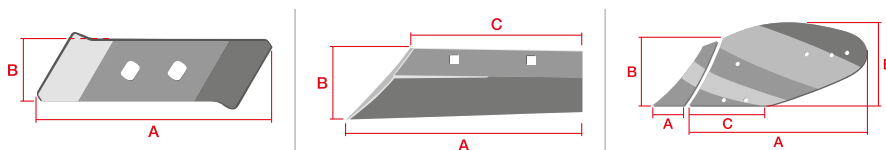
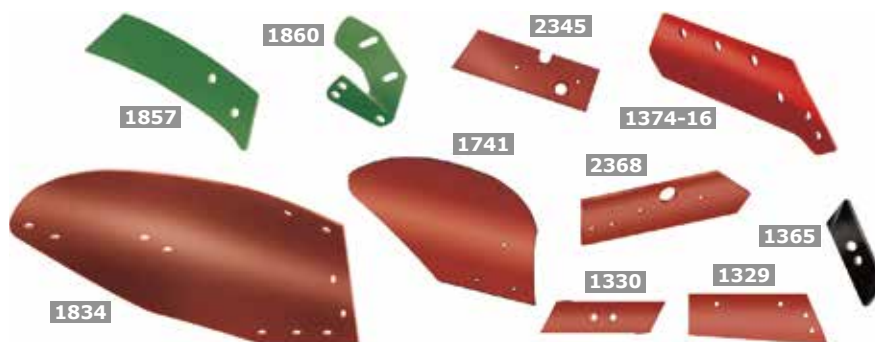

Ref.	→ ←	Grs.		A	B	C		M	F
1329 D ESC	10	2.950	380	390	100	331	1199D	M12	
1329 I ESC	10	2.950	380	390	100	331	1199D	M12	
1330 D	12	1.300	500	260	65	301	1199D	M12	
1330 I	12	1.300	500	260	65	301	1199D	M12	
1365 D CG	12	1.300	500	258,5	65		1199D	M12	
1365 I CG	12	1.300	500	258,5	65		1199D	M12	
1741 D CA1	6	8.440	90	705	341	333	1199B	M10	
1741 I CA1	6	8.440	90	705	341	333	1199B	M10	
1741 D CA1 T	8	9.200	90	705	341	333	1199B	M10	50
1741 I CA1 T	8	9.200	90	705	341	333	1199B	M10	50
1834 D BO	8	20.700		980	440	280	1199B	M12	
1834 I BO	8	20.700		980	440	280	1199B	M12	
1857 D	8	3.285		460	150		1199B	M12	
1857 I	8	3.285		460	150		1199B	M12	
1860 D	10	2.150		220	200		1199B	M12	
1860 I	10	2.150		220	200		1199B	M12	
2345 D	12	5.250		450	140			M12	
2345 I	12	5.250		450	140			M12	
2368 D	12	2.800	350	337	100	274	1199D	M12	
2368 I	12	2.800	350	337	100	274	1199D	M12	
2368 D L	12	4.200	200	487	100	459	1199D	M12	50
2368 I L	12	4.200	200	487	100	459	1199D	M12	50
2368 D 2L	12	4.700	200	537	100	509	1199D	M12	50
2368 I 2L	12	4.700	200	537	100	509	1199D	M12	50